

Operating instructions

Urban MilkShuttle

Calf milk mixer with propelling drive

<http://manual.milkshuttle.com>



Thank you for choosing the Urban "Milk Shuttle". We put our practice into practice when we design our product. All devices are extensively tested at our plant and at additional, selected farms with whom we work closely.

These operating instructions will answer all important questions about your "MilkShuttle" and provide you with a safe and economical operation.

For more support or information, please contact your service partner, or Urban GmbH & Co. KG. For questions, always include the type and serial number. Please enter this information in the following lines so that it is always available:

Type and serial number

Type: _____

Serial number: _____

Manufacturer & Distribution

Urban GmbH & Co. KG

Auf der Striepe 9

D-27798 Hude / Wüstring

Germany

Phone: +49 (0) 44 84/93 80-0

Fax: +49 (0) 44 84/93 80-10

Email: info@urbanonline.de

Internet: www.urbanonline.de

Your service partner:

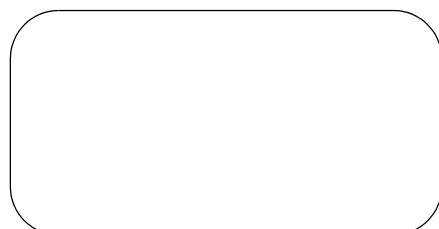

Table of Contents

1	About these operating instructions	5
1.1	Summary.....	5
1.2	Abbreviations and terms used in these operating instructions.....	5
2	For your safety	7
2.1	Symbols used in these operating instructions.....	7
2.2	Warning symbols on the device	8
2.3	Possible dangers	10
2.4	Recommended personnel.....	11
2.4.1	Experienced personnel	11
2.4.2	Instructed personnel	12
2.5	Intended use	12
2.6	Behaviour in an emergency	12
2.7	Laws, standards and directives.....	12
3	Technical data.....	13
3.1	Identification of the product.....	14
3.2	Dimensioned drawings.....	14
4	Overview of Milk Shuttle	15
4.1	Variants.....	15
4.2	Structure	15
4.3	Available languages.....	16
4.4	Operating and display elements	17
4.4.1	Operating panel	18
4.4.2	Agitator motor switch	19
4.4.3	Housing closures	19
4.4.4	Propelling drive brake lever	20
4.4.5	Drawbar head	21
5	Start-up.....	23
5.1	Scope of delivery	23
5.2	Transportation.....	23
5.3	Unpacking	24
5.4	Adjust the drawbar head	25
5.5	Electrical connection	26
5.5.1	Requirements	26
5.5.2	Connecting to the power supply	27
5.6	Wash for first start-up.....	29
5.7	Calibrating.....	29
6	Operation.....	31
6.1	Switching on and off.....	31
6.2	Heating/Agitating.....	32
6.2.1	Filling/mixing the feed	34

6.3	Feeding	36
6.3.1	Removing/dosing feed	36
6.4	Cleaning	39
6.4.1	Milk Shuttle without dosing pump	39
6.4.2	Milk Shuttle with dosing pump (optional)	40
6.5	Moving the MilkShuttle	42
6.5.1	Moving on level ground	42
6.5.2	Moving the MilkShuttle on sloping terrain	43
7	Programming and calibrating	45
7.1	General settings	45
7.1.1	Setting the time and date	45
7.1.2	Setting the user language	46
7.1.3	Changing the temperature unit (Celsius or Fahrenheit)	46
7.1.4	Setting the warning levels for minimum and maximum temperature	47
7.1.5	Display Version and serial numbers	47
7.2	Calibration	48
7.2.1	Calibrate pump (time-controlled)	48
7.2.2	Calibrate the pump with the flow rate controller (optional)	49
7.2.3	Temperature calibration	50
7.3	Programming heating and agitating	51
7.3.1	Overview	51
7.3.2	Operating values	52
7.3.3	Programming the start times	53
7.3.4	Deleting the start times	54
7.4	Programming feeding	55
7.5	Programming the cleaning programs	56
8	What if.....	59
8.1	General errors	59
8.2	Display messages	60
8.3	Determining the operating code	70
9	Maintenance/Repairs	71
9.1	Replace wearing part set	71
9.2	Replacing fuses	74
9.3	Replace batteries	75
9.3.1	Replace main batteries	75
9.3.2	Replace batteries for date/time	77
9.4	Changing the wheels	79
9.4.1	Changing the front wheel	79
9.4.2	Changing the rear wheel	80
10	Spare parts	83
11	Mixing tables	85
11.1	Variant I: water volume given in litres, CMR weight given in kilograms	85
11.2	Variant II: water volume given in litres, CMR weight given in pounds	86
11.3	Variant III: water volume given in gallons, CMR weight given in pounds	87
	Index	89

1 About these operating instructions

These operating instructions will enable the proper and safe use of the Urban "Milk Shuttle" calf milk mixer. Make sure that

- all employees who work with the device have completely read and understood these operating instructions,
- these operating instructions are always accessible and kept near the mixer,
- all of the warning and safety instructions given in these operating instructions are complied with.

1.1 Summary

Chapter 1

Contains general information about these operating instructions.

Chapter 2

Informs you on how to safely handle the device.

Definitely read before start-up!

Chapter 3

Contains the technical data.

Chapter 4

Gives you an overview of the structure and function of the device. All operating and display elements are described in detail.

Chapter 5

Describes how to set up and start up the device.

Chapter 6

Describes all of the activities necessary for daily work.

Chapter 7

Describes all of the menus and parameters of the control computer in detail. The chapter is divided into function groups that correspond to the structure of the software.

Chapter 8

Helps you to eliminate faults.

Chapter 9

Describes all necessary maintenance work and how to replace wearing parts.

Appendix

You will find supplemental information in the appendix.

1.2 Abbreviations and terms used in these operating instructions

CMR calf milk replacer (= concentrated milk powder)

2 For your safety

2.1 Symbols used in these operating instructions



DANGER

DANGER

Identifies a danger that **will** cause death or serious injuries if not avoided..



WARNING

WARNING

Identifies a danger that **can** cause death or serious injuries if not avoided.



CAUTION

CAUTION

Identifies a danger that can cause light or medium injuries or material damage if not avoided.



Danger of crushing

This symbol warns you of the danger of crushing parts of your body in moving machine parts.



Self-starting machine parts

This symbols warns of the dangers due to self-starting machine parts.



Electrical voltage

This symbol warns of the dangers of electric shock due to high electrical voltage.



INFO





Information

This symbol identifies references and tips that can be used, for example, for especially economical and environmentally-friendly operation.

2.2 Warning symbols on the device

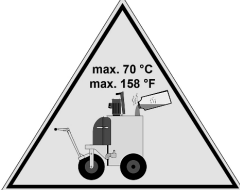

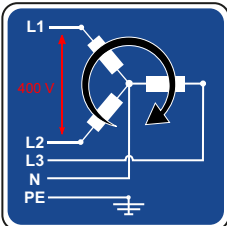
Figure 2/1: Position of the warning symbols and the name plate

Nr.	Symbol	Anbringungsort
1		Warning sign at the container opening
2		Warning sign at the container opening ("Do not fill liquids that exceed a temperature of 70°C (158°F)")
3		Warning sign at the container opening
4		Name plate at the feed container
5		Indicating label at the MilkShuttle's mouting plug (400 V only)
6		Warning sign at the closures of the control electronics housing lid
7	<p>FÄR EJ KÖRAS TORR DO NOT RUN DRY NICHT TROCKEN LAUFEN N DOIT PAS MARCHER A SEC</p>	Indicating label dosing pump on the container lid
8		Warning sign above the drain valve of the dosing pump: („If the MilkShuttle is taken temporarily out of operation, open the drain valve in order to drain the dosing pump so that no harm will occur to the pump during freezing periods“)

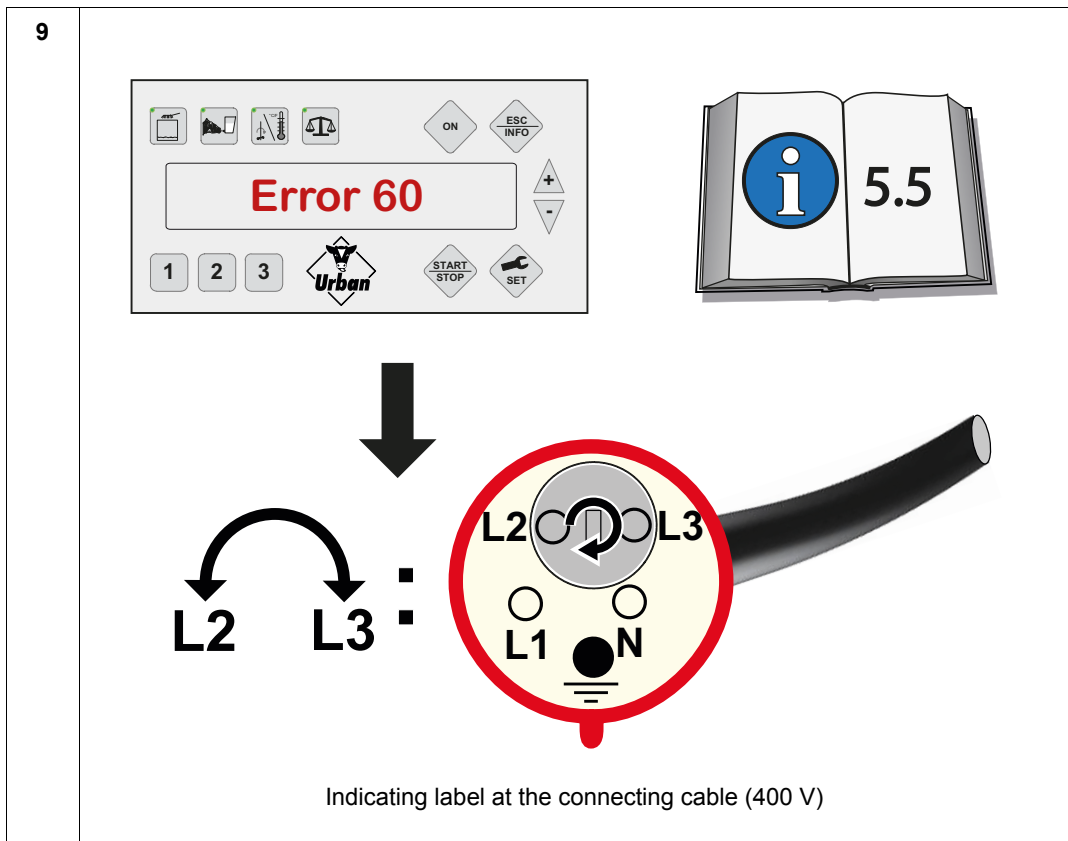

2.3 Possible dangers

The "Milk Shuttle" has been constructed and manufactured using the state-of-the-art technology and according to the rules, standards and directives stated in chapter 2.7.



ATTENTION

WARNING

For sloping terrain (more than 3 % slope), danger of being run over.

- Walk behind the device (against the direction of travel, see figure 2/2).
- Grasp the drawbar handle with both hands.

Do not travel along routes with slopes of more than 10 %!

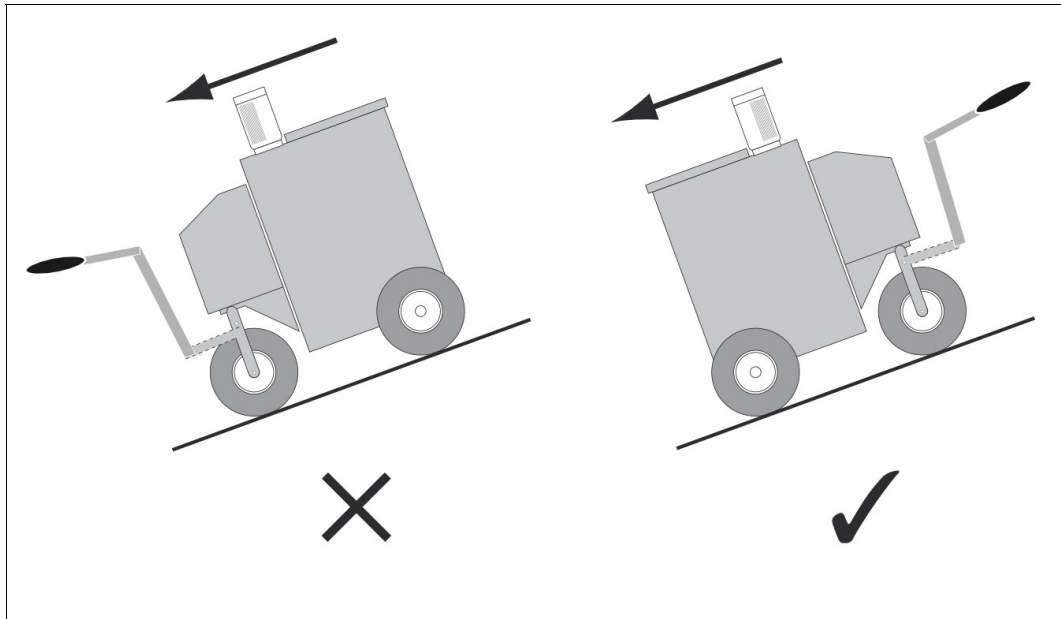

Figure 2/2: Moving on slopes

The device poses no danger when the safety instructions given in these operating instructions are applied.

2.4 Recommended personnel



CAUTION

The Urban "Milk Shuttle" has a considerable mass, especially with a full load. It may therefore only be operated by persons with the appropriate physical, mental and technical capabilities.

Action	Requirement
Start-up	Experienced personnel
Installation/Modification	
Operation	Instructed personnel
Electrical maintenance/repairs	Skilled electrical personnel
Mechanical maintenance/repairs	Experienced personnel

2.4.1 Experienced personnel

Experienced persons are people who are knowledgeable in a specific field due to their technical training and experience and are familiar with the pertinent occupational safety and accident prevention regulations as well as the general acknowledged rules of technology.

2.4.2 Instructed personnel

Instructed persons are people who have received instructions from an experienced person about their assigned tasks and the possible dangers of improper behaviour and were trained as necessary as well as instructed on the necessary protective equipment and protective measures.

2.5 Intended use

The "MilkShuttle" is used to mix and transport liquid nutrition for livestock.

Any other use, such as:

- transporting persons and animals
- filling with combustible substances (e. g. fuels)
- heating other substances

is not permitted.

Any **changes to the device** (e. g. fixing the controller) are **not permitted**.

2.6 Behaviour in an emergency

1. Immediately unplug the power plug.
2. For devices with dosing (optional):
Switch off the device at the display.
3. Only start up the device after the emergency situation has been eliminated.
4. If there are obvious signs of damage to the device have a specialist check and repair the device as necessary before starting up again.

2.7 Laws, standards and directives

The device was developed with consideration of the following laws, standards and directives:

2006/42/EG	EC Machinery Directive
DIN/EN/ISO 12100	Safety of Machines
ProdSG	Product safety law

3 Technical data

	Type 100	Type 150	Type 200	Type 250
Dimensions				
Length (without drawbar) [cm]	106	117		
Length (with drawbar) [cm]	143	154		
Width [cm]	80	82		
Height [cm]	98	98	110	123
Weight fully equipped [kg]	164	179	182	185
Power supply [V~]	230/400			
Power consumption max. [VA]	3000	3.000/6.000		
Current consumption max. [A]	13/13			
Protection class	I			
Mixing volume max./min. [l]	100/15	150/30	200/30	250/30
Transport volume max. [l]	depending on slope of covered distance (see figure 3/1)			
Noise emission	<72 dbA			

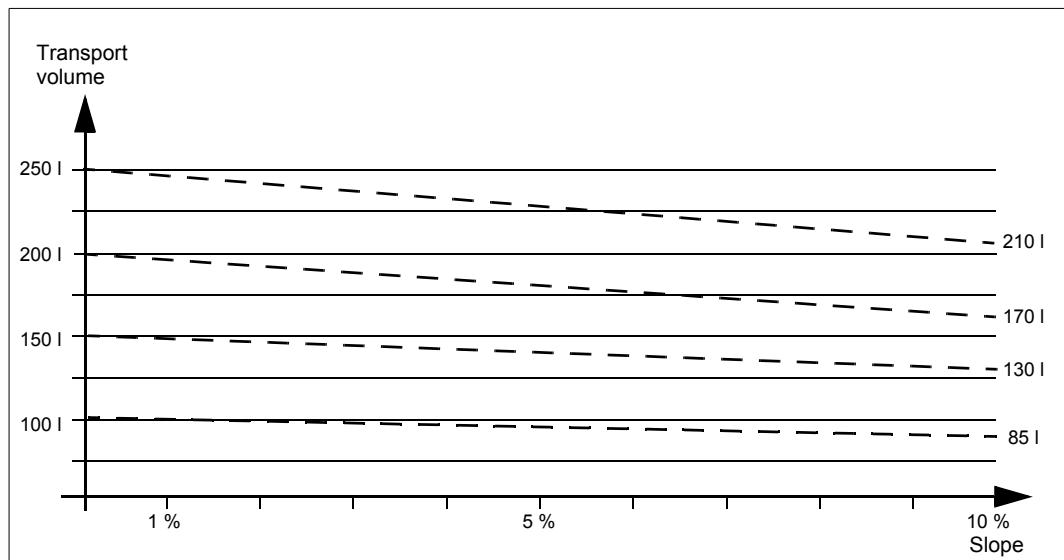

Figure 3/1: Permitted transport volume

3.1 Identification of the product

These operating instructions apply to all "Milk Shuttle" calf milk mixers with the name plate illustrated in the following.

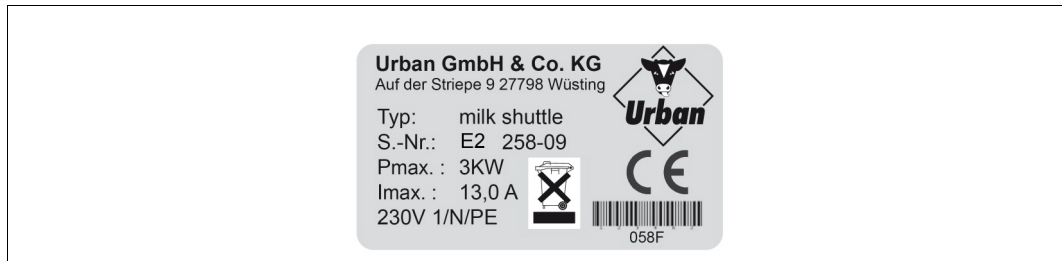

Figure 3/2: Name plate on the device (example)

3.2 Dimensioned drawings

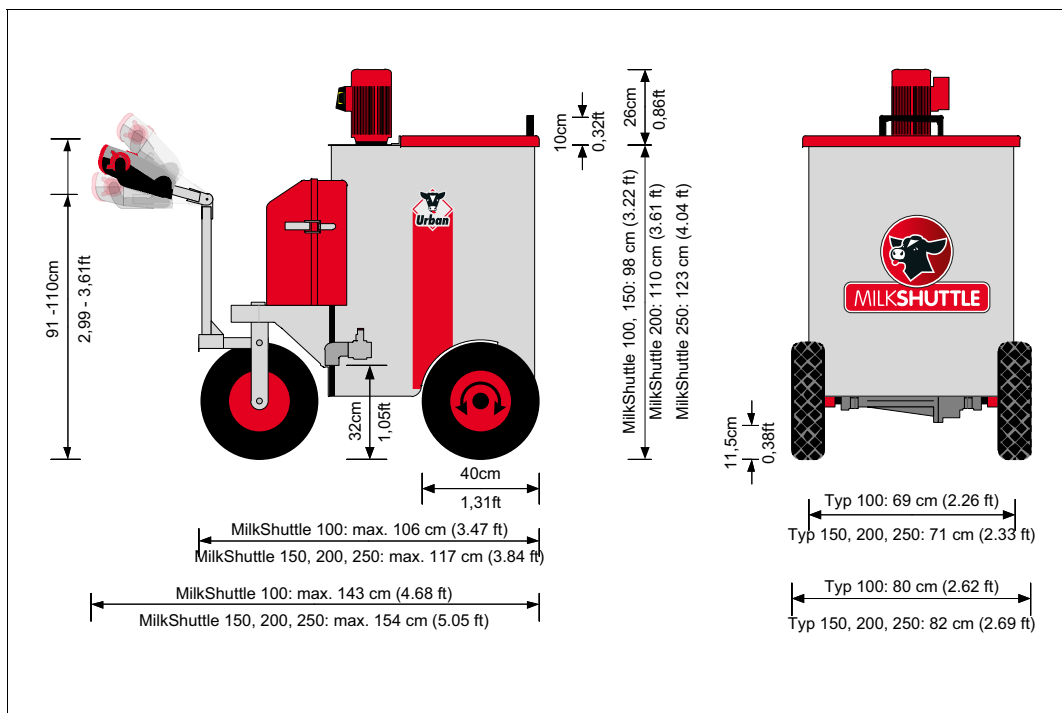

Figure 3/3: Dimensioned drawing MilkShuttle

4 Overview of Milk Shuttle

4.1 Variants

	MilkShuttle			
	100	150	200	250
Heating 2.500 W (240 V)	✓			
Heating 5.500 W (400 V)		✓	✓	✓
Agitator with 2 different speeds (700 / 1400 U/min)	✓	✓	✓	✓
Drain valve 1,5"	✓	✓	✓	✓
Pump nozzle with pump and quantity preselection	✓	✓	✓	✓
Cleaning program (only in conjunction with pump nozzle/pump)	✓	✓	✓	✓
Propelling drive (battery, 24 V)	✓	✓	✓	✓
Flow rate sensor (only in conjunction with pump nozzle/pump)	optional			

4.2 Structure

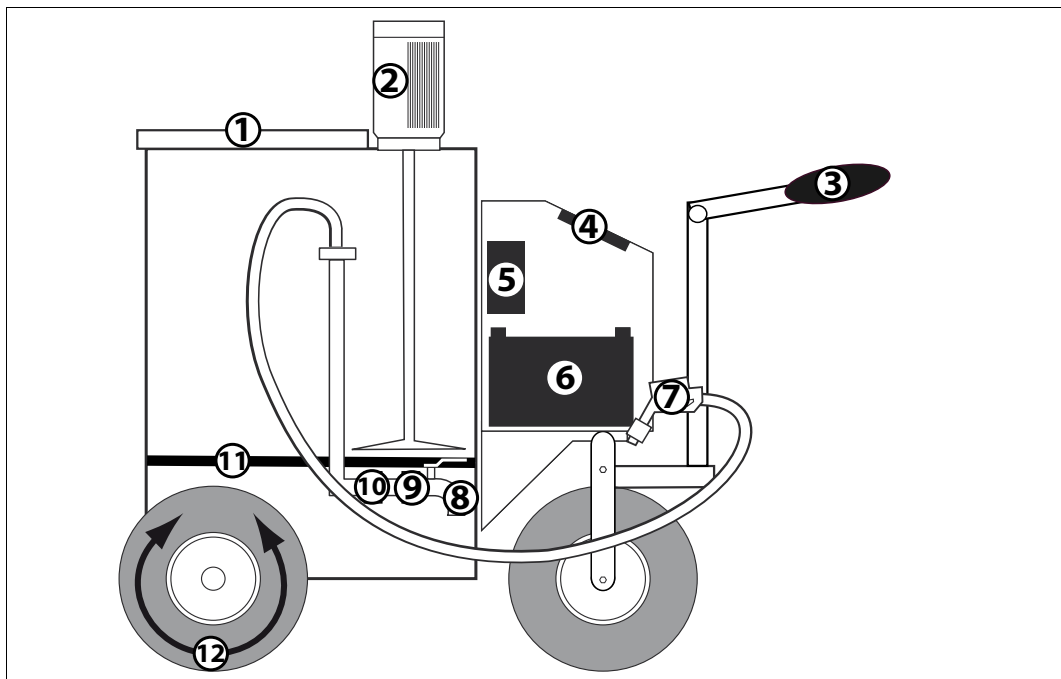

Figure 4/1: Schematic structure of the MilkShuttle

Nr.	Designation
1	Container lid with seal
2	Agitator motor
3	Drawbar head with drive control lever
4	Operating panel
5	Power- and control electronics
6	Batterie(s) 12 V

Nr.	Designation
7	Pump nozzle
8	Drain valve 1,5"
9	Dosing pump (battery operated)
10	Flow rate meter (optional)
11	Bottom heating
12	Propelling drive (for- or backward)

4.3 Available languages

The user interface for the operation of the MilkShuttle can be set to a variety of different languages. The number of available user languages is constantly increasing. As of version 1.20 of the MilkShuttle firmware, not all available user languages can be included in the firmware any more due to storage limitations. This means that as of firmware version 1.20, MilkShuttle cannot be delivered with all available languages included, only a subset of languages can be shipped with a MilkShuttle. For that purpose, the available languages are grouped into regional language packages. Each feeder is shipped with a firmware that contains exactly one of these language packs. The following table offers an overview of the available language packages A to C and E (status: Juli 2014):

Package A Central Europe	Package B Northern Europe	Package C Eastern Europe	Package E Eastern Europe/Asia
German (de)			
English (en)			
French (fr)	Dänisch (da)	Czech (cs)	Turkish (tr)
Dutch (nl)	Swedish (sv)	Polish (pl)	Hungarian (hu)
Spanish (es)		Russian (ru), latin character set	Slovenian (si)
Portuguese		Lithuanian (lt)	Romanian

You may switch over to another user language that is included in your language package at any time (see chapter 7.1.2, page 46). If you would like to use a language that resides inside a language package different from yours, you have to replace the circuit board of your MilkShuttle. Please contact your service technician in this case. You may determine the version of the language package installed on your MilkShuttle via the operating code (see chapter 8.3, page 70).

4.4 Operating and display elements



Figure 4/2: Overview of operating elements

Nr.	Designation
1	Agitator motor switch
2	Operating panel
3	Drawbar head
4	Pump nozzle
5	Operating lever „Release brake“

4.4.1 Operating panel

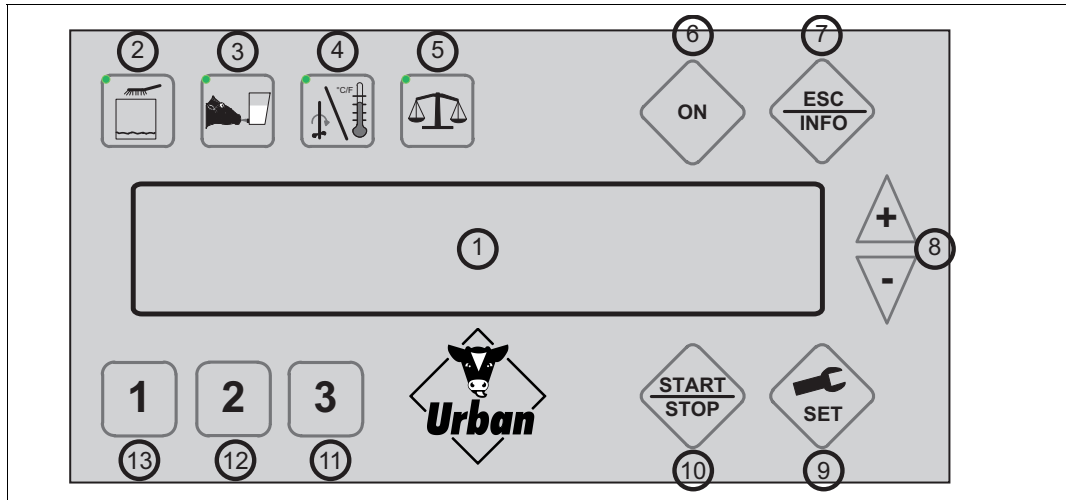

Figure 4/3: Operating panel

Briefly pressing a key switches on the display lighting.

No.	Function	Explanation
1	Display	Text display of functions
2	Cleaning	Cleaning program selection
3	Feeding	Feeding program selection
4	Display temperature Heating/Agitating	Press briefly: temperature display Press longer (>2 s): "Heating/Agitating" program selection
5	Calibrating	Calibrating program selection <div style="display: flex; flex-direction: column; gap: 5px;"> <div>1 Calibrate pump for the feeding program</div> <div>2 Calibrate the temperature</div> </div>
6	Switching on and off	Press longer (>2 s): Switch the Milk Shuttle on and off
7	Back/Info	Fault message/Warning
8	Keys	Programming mode: Increase/decrease current value by one step When the key is kept pressed down, the value increases/ decreases continuously
9	Set	Press briefly: Programming mode: Continue to next setting value Press longer (>2 s): Switch to programming mode
10	Start/Stop	Press briefly: Start "Long agitate interval", stop "Agitating" Press longer (>2 s): Switch between heating and agitating
11	3	Preselection key
12	2	Preselection key
13	1	Preselection key

4.4.2 Agitator motor switch



Figure 4/4: Agitator master switch

4.4.3 Housing closures

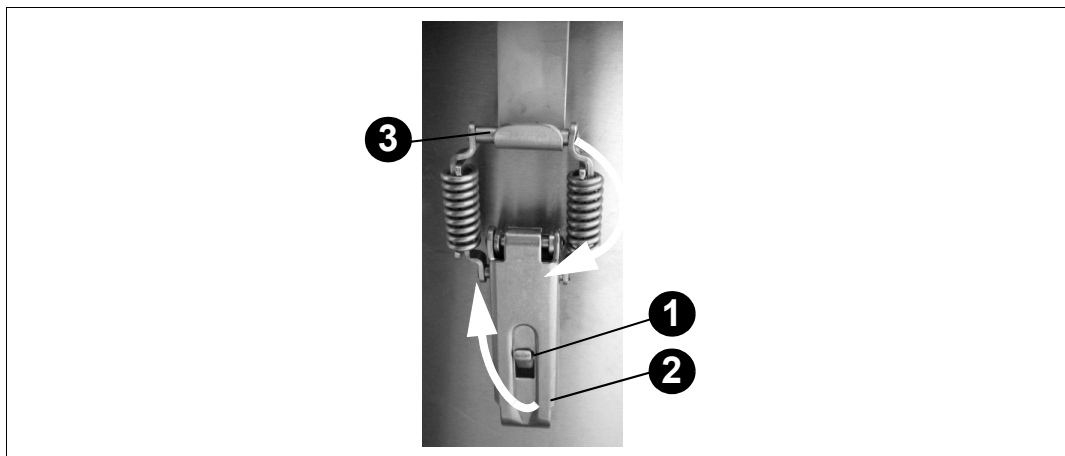

Figure 4/5: Housing closure in detail

The lid of the feed container and that of the control casing are equipped with self-locking snap closures.

To open a snap closure, proceed as follows:

1. Press down safety lever **1** .
2. Fold up closing lever **2** .
3. Open closure completely **3** .

Closing occurs in reverse order. Make sure the safety lever engages audibly.



INFO

Information

To extract the feed, the lid closures of the feed container must be opened. Otherwise, negative pressure could develop in the feed container which would hamper the extraction.

To open the closures for the control housing you must first remove the cotter pins.

4.4.4 Propelling drive brake lever



CAUTION

CAUTION

When parking on sloping ground the brake must always be blocked. Otherwise the device might move out of control.

When the brake is released, secure the Milk Shuttle against rolling away!

The propelling drive brake lever **1** is under the feed container at the drive motor. The brake lever can release the brake of the drive motor. The Milk Shuttle can therefore be moved even when the batteries are discharged.

- Brake lever up: Brake released
- Brake lever down: Brake blocked (normal operation) - the brake is released via the propelling drive.

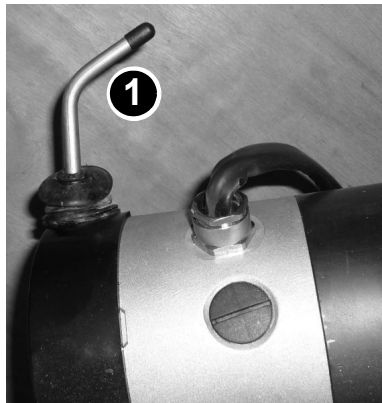

Figure 4/6: Propelling drive brake lever



INFO

Information

Only actuate the propelling drive brake lever in case of defective propelling drive or discharged batteries.

When the brake is released, the Milk Shuttle can only be moved at half speed at most.

4.4.5 Drawbar head

The drawbar head controls the Milk Shuttle and activates the pump nozzle.
 The safety stop button ❷ stops the driving movement of the Milk Shuttle.

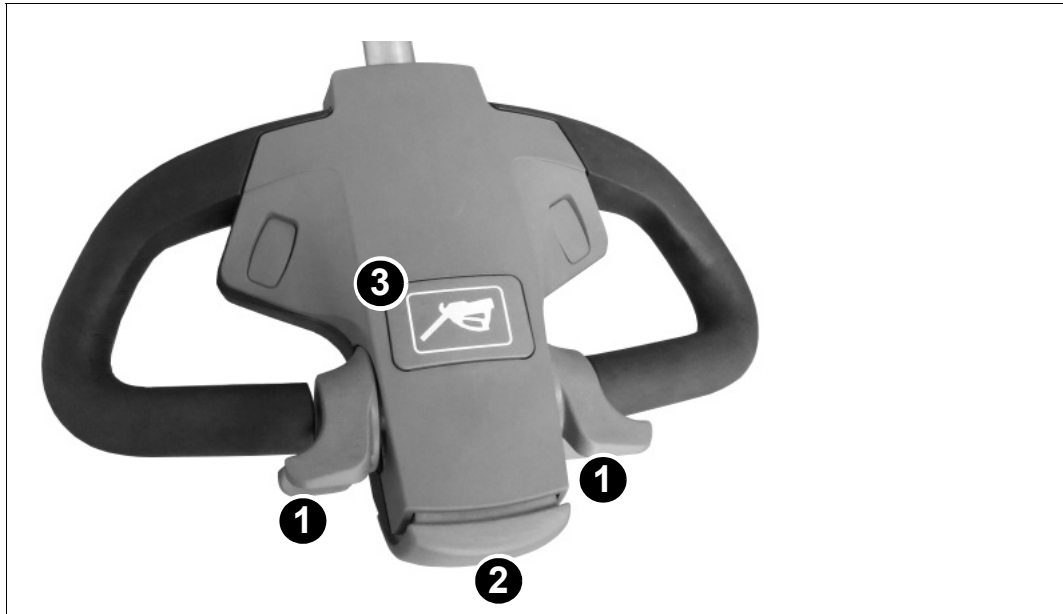

Figure 4/7: Drawbar head

No.	Designation
1	Speed and direction controller
2	Safety stop button
3	Pump/Pump nozzle release button

The controllers ❶ are used to choose the direction of travel and the driving speed. Both controllers have the same functions - you may use either the left or the right controller. The further you turn a controller in one direction, the faster the Milk Shuttle moves. When a controller is released, it returns automatically to the central position and the Milk Shuttle is braked until standstill.

Press controller down: Forwards driving direction (pull Milk Shuttle).

Press controller up: Backwards driving direction.



WARNING

Danger of injuries caused by uncontrolled driving movements.

- Never fix the controllers in any kind of position.
- Ensure free movement of the controllers.

Check the safety stop for function before each trip.

Overview of Milk Shuttle

In dangerous situations, the safety stop button ② immediately brakes the Milk Shuttle to a complete standstill and then permits it to roll back a few centimetres in the opposite direction. This can prevent injuries (e. g. being caught by the moving Milk Shuttle).

5 Start-up

5.1 Scope of delivery

Please check the delivery for completeness before the installation.

Included in the delivery:

- "MilkShuttle" calf milk mixer
- Allen key 6 mm (for adjusting the drawbar height)
- Pump nozzle with electric trigger (optional)
- Glass fuse 6.3 A, 5 x 20 MT
- Blade-type fuse 10 A
- Blade-type fuse 1 A
- Puller screw for changing the wheels (optional)
- Quick guide "MilkShuttle" (2 pages, laminated)
- These operating instructions

5.2 Transportation

The "Milk Shuttle" calf milk mixer may only be transported (in addition to moving on its own wheels) in an upright position on a stable support, such as a pallet.

To prevent the device from overturning and rolling away during the transport, secure it with a lashing strap.



CAUTION

CAUTION

Material damage to device possible

Never lift up the device directly at the bottom frame, such as with a lift truck or a forklift. This could damage the components and connections on the bottom.



INFO

Information

Refer to the tyre sidewalls for the correct tyre inflation pressure.

5.3 Unpacking

Required tools: Knife / cutter



CAUTION

CAUTION

The "Milk Shuttle" must be lifted to be unpacked. Therefore, always include a second person to help unpack.



Figure 5/1: Unpacking

Carry out the following steps to unpack:

1. Carefully cut the packaging foil and remove it.
2. Cut open and remove the lashing straps and cable ties.
3. Check the inflation pressure of the tyres and pump up as necessary.
4. Tilt the "Milk Shuttle" slightly over one of the rear wheels and remove the transport block **3** under the wheel axle as far as possible.
5. Tilt the Milk Shuttle slightly over the other rear wheel and remove the transport block **3** completely.

6. Lift the "Milk Shuttle" by the drawbar **①** so that the transport block under the feed container **②** can be removed.
7. Adjust the drawbar head as described in chapter 5.4.

**CAUTION**

Before moving the Milk Shuttle, familiarize yourself with the operation of the controllers (*chapter 6.5*).

8. Slowly move the Milk Shuttle off the pallet. While doing so, make sure that both rear wheels set down at the same time.

5.4 Adjust the drawbar head

Required tools: Hexagon spanner 6 mm

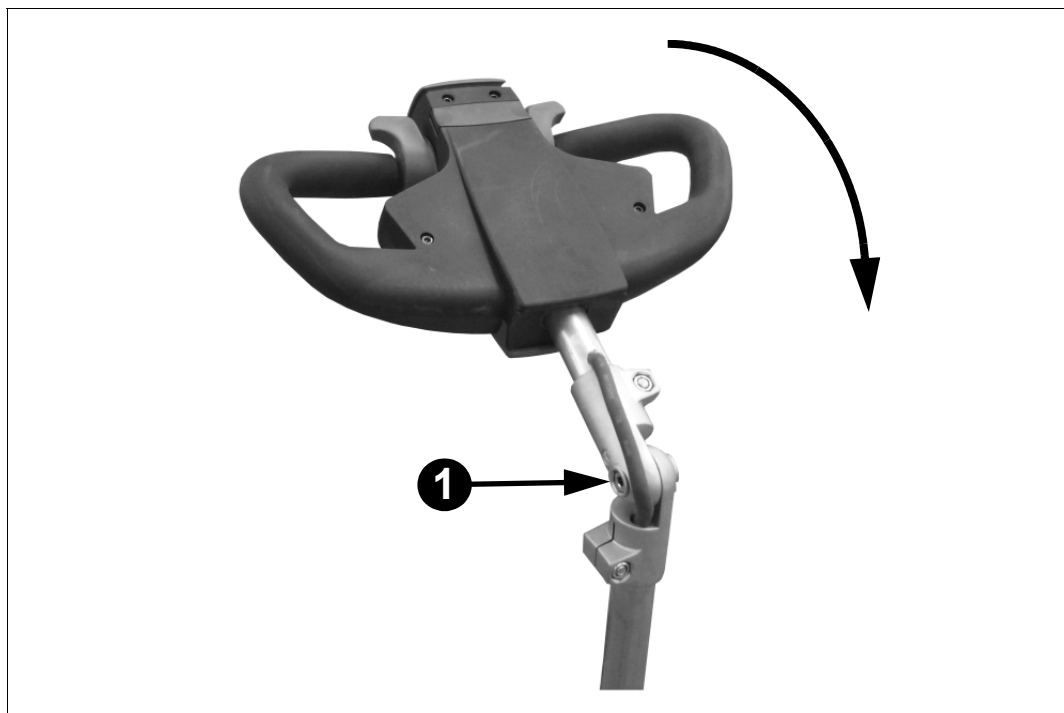

Figure 5/2: Adjusting the drawbar head

Carry out the following steps to adjust the drawbar head:

1. Loosen hexagon socket screw (**1**) with Allen key.
2. Adjust the drawbar head to the required height.
3. Tighten the hexagon socket screw (**1**) again.

**CAUTION**

When adjusting the drawbar head, make sure no cables are pinched or over-stretched.

5.5 Electrical connection

5.5.1 Requirements

The electrical connection must be

- secured by a **separate fuse (16 A)**,
- protected by a **residual current circuit breaker (FI, 30 mA)**,
- and be wired as per IEC 60364-7-705. In case of an operating voltage of 400 V, assure the clockwise phase sequence of your rotary field (see chapter 5.5.2, page 27).



CAUTION

DANGER

If the device is damaged whilst operating without a residual current circuit breaker dangerous electrical voltage can be present at the housing. **Operation without a residual current circuit breaker is therefore not permitted.**

Depending on the heating used, the following electrical connections are required:

Electricity supply systems 230 V/400 V (EU)

	Heater 2,500 W	Heater 5,500 W
Operating voltage [V]	230, L/N/PE	400, L1/L2/L3/N/PE
Fuse min. [A]	16	3 x 16
Plug connector (EU)	CEE 16 A (blue), 3-pin	CEE 16 A (red), 5-pin
Plug connectors of other countries	according to local standard	according to local standard

Electricity supply systems 110 V/220 V (Canada, U.S., Japan)

	Heater 2,500 W	Heater 5,500 W
Operating voltage [V]	240	240
Fuse min. [A]	16	30
Plug connectors of other countries	according to local standard	according to local standard

5.5.2 Connecting to the power supply

To connect the device, you will need a connecting cable with the appropriate plug connectors (CEE blue or red, not included).



CAUTION

There may be no **rolled-up** cable reel in the supply lead.

CAUTION Fire hazard!

1. Connect the plugs of the cable to the fixed socket outlet.
2. Lay the connecting cable so that it doesn't pose a stumbling hazard.
3. Connect the other end of the connecting cable to the outlet of the "Milk Shuttle" (see figure 5/3).

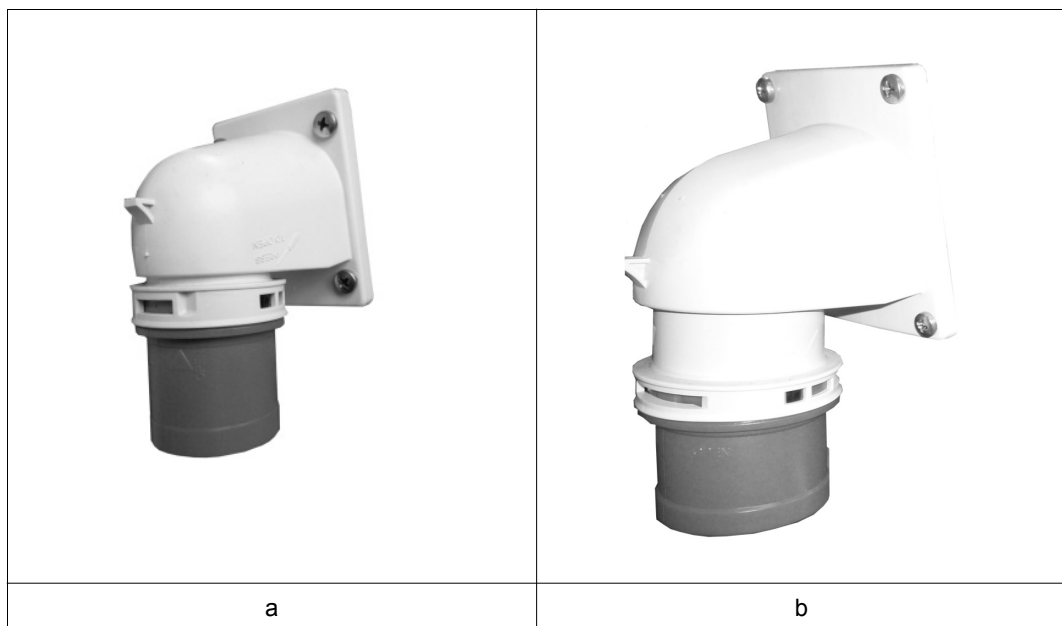

Figure 5/3: Electrical connection at the Milk Shuttle (examples)

a: CEE blue, 3-pin (230 V AC)

b: CEE red, 5-pin (400 V AC)

4. Leave the device connected to the power supply for approx. 12 hours to charge the internal batteries.



INFO

Information

Whilst the battery is charging, you can familiarize yourself with the device and do the programming.



CAUTION

CAUTION

For 400 V power supply, ensure that the neutral line (N) of the outlet and of the extension cord is connected. If you are unsure commission an electrician to check the connections.

If you switch on the MilkShuttle without a connected neutral wire, a protective mechanism prevents the start up of the device. Subsequently, a fault message is shown on the MilkShuttle's display (Fault 60 - No mains voltage).

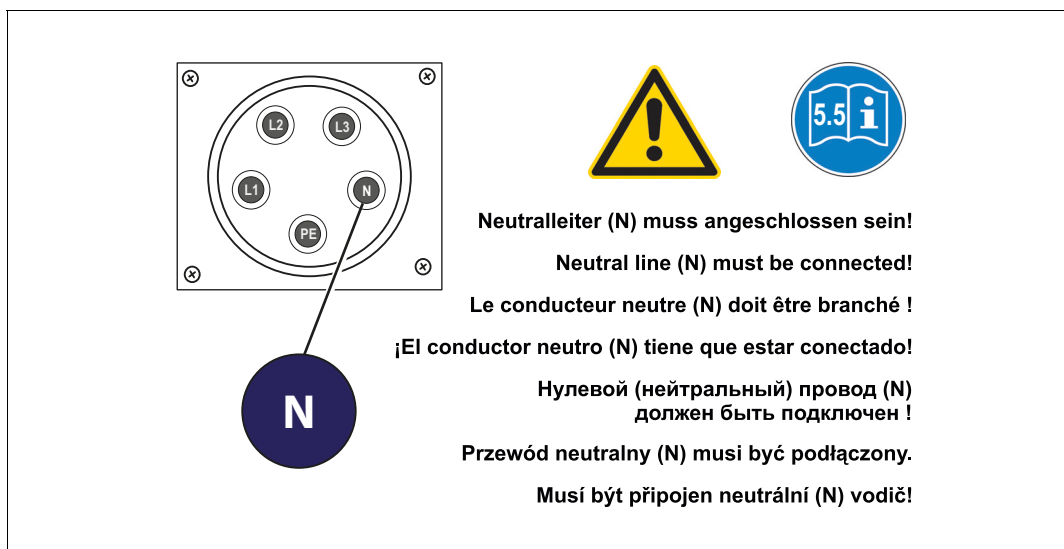

Figure 5/4: Neutral line warning sign on connecting cable



INFO

Information

The protective mechanism also prevents the start up of the MilkShuttle in case of an anti-clockwise phase sequence of the rotary field. Therefore, the fault message *No Mains voltage* (fault code 60) may be caused either by a missing neutral wire (N) or by the anti-clockwise phase sequence of the rotary field. The phase sequence of the rotary field may be corrected by changing the phases L2 and L3. For that purpose, the connecting cable (400 V) of the MilkShuttle is equipped with an integrated phase changing switch. Inside the connector of the cable, the two pins for the phases L2 and L3 are mounted on a round plate that can be rotated by 180 degree. Use a screwdriver (width of blade: 6 mm) in order to rotate the plate and subsequently change the phases L2 and L3. Please be aware of the fact that the protective mechanism will be triggered by too high or too low mains voltage also.



Figure 5/5: Phase changing switch of the connecting cable (CEE)

5.6 Wash for first start-up

When delivered, there is a small amount of antifreeze agent in the pump. Before filling the Milk Shuttle with calf milk replacer (CMR) or whole milk for the first time, the device must be washed with approx. 30 litres of water.

5.7 Calibrating

Calibrate the dosing pump before productive use, see chapter 7.2.1 on page 48.

6 Operation



WARNING

WARNING

Shutting down the device in case of frost.

• Devices without dosing unit

It is permitted to shut down the device when temperatures drop below 0°C. The drain valve (see figure 6/2 on page 36) must be open.

Devices with dosing unit

It is **not** permitted to shut down the device when temperatures drop below 0°C.

This could otherwise damage the dosing pump.

6.1 Switching on and off

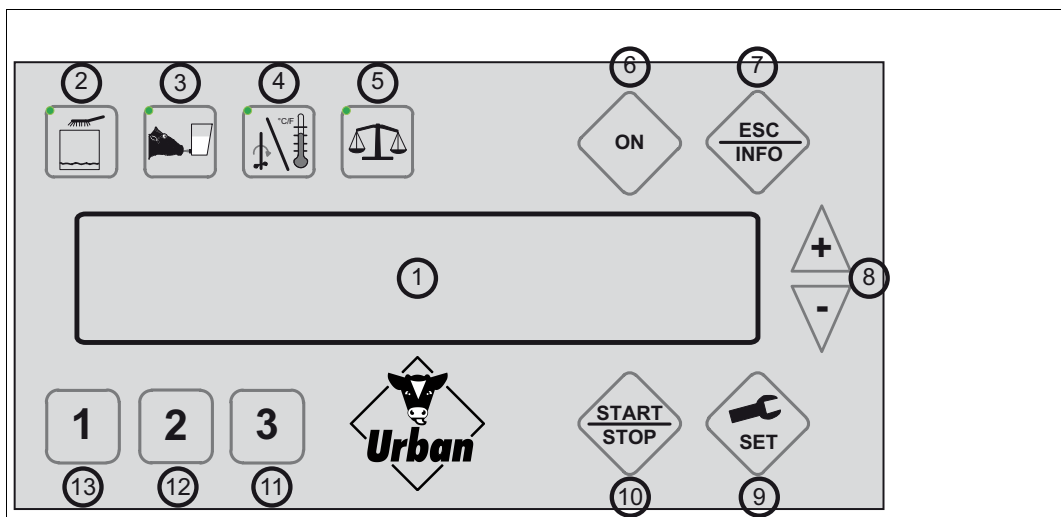



Figure 6/1: Operating panel of the Milk Shuttle

Operating panel legend:

No.	Description
1	Display
2	"Cleaning" key
3	"Feeding" key
4	"Heating/Agitating" key
5	"Calibrate" key
6	"ON" key
7	"ESC/INFO" key
8	"Plus" and "Minus" keys
9	"SET" key
10	"START/STOP" key
11	Preselection keys "1", "2" and "3"
12	
13	

Pressing the  key switches the Milk Shuttle on and off. After switching on, the display shows the main menu centred in the control panel:

16.07.14	10:30:32
MilkShuttle	105A31

Switching on will also switch on the display lighting, but this switches off after a short time. Briefly pressing any key will turn the display lighting back on.

During battery operation, the display and the control stay active for 15 minutes if no key is pressed. The electronic system then switches off completely. This prevents the battery from discharging too quickly.

When the Milk Shuttle is connected to mains voltage, the display lighting switches off. The display and the control always remain active and can only be switched off

by pressing and holding down the  key.

The propelling drive on devices with this drive can be operated when the display is switched on.

6.2 Heating/Agitating

The Heating/Agitating function heats the filled water or feed to a preset target temperature. The following values are factory defaults:

- Target temperature: 40 °C
- Agitating: 10 seconds
- Break: 15 seconds

How to adjust these values to your requirements is given in *chapter 7.3, page 51*.

The function *Heating/Agitating* only works on mains operation. If your MilkShuttle is running on battery power only (no mains supply), this function is not available.



ATTENTION

ATTENTION

No heating-up while the feed container is empty!

- **Please make sure that liquid is filled into the feed container once the heating is switched on.**

The minimum fill quantity of the container during the heating phase amounts to 30 litres (MilkShuttle 150, MilkShuttle 200, MilkShuttle 250). When using the Milk-Shuttle 100, heating is allowed once 15 litres of liquid are filled into the feed container.

- Heating may **never** switched on while the feed container is empty! Otherwise the heater may be damaged!



INFO

Information

Always adapt the speed of the agitator to the type of feed you use:

- Slow (Level I): whole milk, heating phase
- Fast (Level II): concentrated milk powder, heating phase

Operation/Standby

After switching on, the control for the heater and the agitator is in standby mode at first. The start display is shown:

```
16.07.14  10:30:32
MilkShuttle  105A31
```

This prevents the heater and agitator from running when the feed container is empty.

After filling with whole milk or water, press the  key (approx. 2 seconds) to switch on the heating control.

Briefly pressing the  key switches the control back to the "Standby" operating mode.

Before the start, the Heating/Agitating function checks if times are programmed under "Start time 1". If no start time is programmed, the Milk Shuttle briefly displays the following menu and begins to heat and agitate after one or two seconds:

```
1:Automatic Heating
1:---:-- active
```

```
1:Automatic Heating
1:Start in --:--:--
```

If Start time 1 is programmed, the Milk Shuttle begins to heat/agitate at 3:30 p.m., exactly in 2 hours and 12 seconds:

```
1:Automatic Heating
1:15:30 active
```

```
1:Automatic Heating
1:Start in 02:00:12
```

The heater begins to heat the feed to the set temperature. The agitator runs at the set operating and pause times.

Briefly pressing the  key lets you start heating/agitating before the set start time.

The display alternately shows the target temperature, actual temperature and the agitating time:

```
Heating  Agitating
16.3 C   00:28
```

← blinking 1 sec →

```
40.0 C  Agitating
16.3 C   00:28
```

Once the agitating time has expired, the display alternately shows the break time:

```
Heating  Break
16.3 C   00:28
```

← blinking 1 sec →

```
40.0 C  Break
16.3 C   00:28
```

Long-term operation

Briefly pressing the  key starts the "Long-term operation" function. The agitator is switched on for 5 minutes (fast or slow). The long-term operation time cannot be changed. The display alternately shows the target and actual temperatures and the remaining long-term operation time:

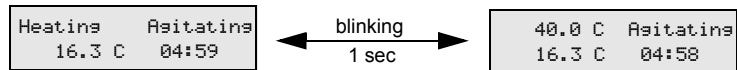

Pressing the  key again cancels the long-term operation function.

Briefly pressing the  key (less than 0.5 seconds) shows the current actual temperature for five seconds:

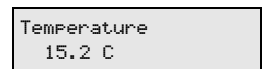

This function can be called up from almost all submenus.

6.2.1 Filling/mixing the feed

CAUTION



Danger of injuries caused by self-starting agitator.

Never reach into the container when the device is switched on!

6.2.1.1 Mixing calf milk replacer (CMR)

Mixing tables



INFO

In chapter 11 on page 85 you can find three mixing tables, which will facilitate the preparation of milk feed from water and calf milk replacer. Each table lists the combination of water amount and milk powder amount needed in order to prepare a given quantity of milk feed with a given solids content. In total three different mixing table variants are available, specifying the water amount in litres or gallons and specifying the required amount of powder in kilograms or pounds.

Information





INFO

Comply with the specifications of your CMR manufacturer for the optimal mixing temperature.

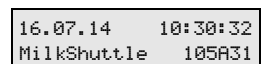
1. Fill 3/4 of the required water amount in the container.
2. Press the  key on the operating panel for approx. 2 seconds to switch on the control. The display shows the start window:

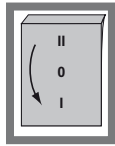



3. Press the  key for approx. 2 seconds.
4. Start the agitator at Level I (**slow mode**).
5. Heat the feed to a temperature that is approx. 5°C above the recommended feeding temperature,
e.g.: required feeding temperature 38°C -->heat to 43°C
6. Once the required temperature is reached:

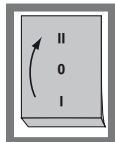

- Set the agitator to Level II (**fast mode**) and briefly press the  key on the operating panel to start long-term operation of the agitator.
7. **Slowly** add the required amount of calf milk replacer (CMR).
 8. Then add the remaining amount of water.
 9. Wait until the required temperature is reached, as necessary.
 10. Serve the feed immediately.
 11. Then start the cleaning program (*see chapter 6.4, page 39*).

Information



INFO

The heating phase can be potentially omitted if using hot water for mixing.

6.2.1.2 Fill whole milk

1. Fill the required amount of whole milk.
2. Press the  key on the operating panel for approx. 2 seconds to switch on the control. The displays shows the start window:

16.07.14	10:30:32
MilkShuttle	105A31

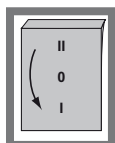

3. Press the  key for approx. 2 seconds.
4. Start the agitator in interval mode at Level I (**slow mode**).
5. Heat the feed to the required temperature.
6. Serve the whole milk immediately.

Then start the cleaning program (*see chapter 6.4, page 39*).

6.3 Feeding



INFO

Information

The container lid is well sealed. This prevents the feed from spilling during transport.

Before feeding, open the snap closures of the container lid to prevent negative pressure from developing in the container during feeding.



INFO

Information

After starting up, the feeding function must be first calibrated to the required unit (litre or kilogram) (see *chapter 7.2.1, page 48* or *chapter 7.2.2, page 49*).

Otherwise, the required feed amount can deviate considerably from the set value.

6.3.1 Removing/dosing feed

6.3.1.1 Manual removal



Figure 6/2: Manually removing the feed

1. Open the lid closures of the feed container.
2. Place an appropriate container underneath the outlet.
3. Open the drain valve by moving the valve lever in the direction of the arrow.
4. Remove the required feed amount.
5. Close the drain valve by moving the valve lever against the direction of the arrow.

6.3.1.2 Automatic dosing (optional)



1. Open the lid closures of the feed container.



2. Press the  key on the operating panel for approx. 2 seconds to switch on the control. The display shows the start window:



```
16.07.14  10:30:32
MilkShuttle  105A31
```

3. Press and hold the  key (approx. 2 seconds). The Milk Shuttle selects the dosing amount last used off:

```
Feeding  ██████
1: 04.0  ██████
```

4. Use the preselection keys (see Figure 4/3 on page 16) to choose from three pre-programmed feed amounts. Choose ,  or  if you require a different feed amount. How to program the preselection keys with your own values is described in chapter 7.4, page 55. When delivered, the preselection keys are assigned the following feed amounts:

Preselection key	Feed amount
	2 litres (or 2 kg)
	3 litres (or 3 kg)
	4 litres (or 4 kg)

5. Use the  /  keys to individually change the dosing amount during feeding. These changes are not saved. If you exit the Feeding menu with this value, it is retained and displayed at the next start.

6. Take the pump nozzle from the drawbar holder and hold it over the intended container.

7. Actuate the trigger **1** of the pump nozzle; the feed pump starts and pumps the required feed amount into the container. Once the feed amount is dosed out, release the pump nozzle trigger, move the Milk Shuttle to the next container and actuate the pump nozzle trigger again.

8. In addition to the set dosing amount, the display shows the already dosed amount

```
Feeding  ██████
1: 04.0 02.1  ██████
```

9. You can cancel feeding with the  key.

10. If you briefly press the  key during the dosing procedure, you can check the flow behaviour of the flow rate controller:

```
03.0  160 Pulses
02.1  160 Pulses
```

The calculated values are displayed.

11. The locking device **2** can be used to fix the trigger in an opened position. Pulling on the trigger again releases the locking device. The dosing will not be triggered if the battery voltage is too low (protection against exhaustive discharge, see *figure 6/4*). Charge the battery first. When the locking device is fixed (see *figure 6/3 on page 38*), you can press the  key to dose the required feed amount several times without having to actuate the trigger again.
12. Alternatively you may trigger the portion dispense by means of the „pump nozzle“ push button located on the drawbar head (see *figure 6/6 on page 42, digit 3*).

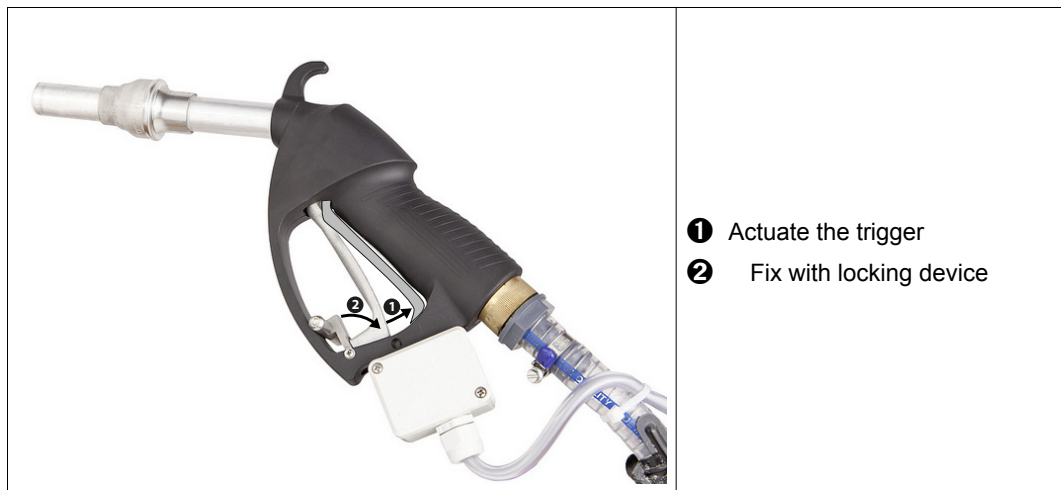

Figure 6/3: Actuate the pump nozzle

6.3.1.3 Charge condition



INFO

Information

When not in use, connect the device to the power supply. This keeps the batteries charged and ready for operation.

To check the charge condition, you must unplug the power plug in order for the correct value to be displayed.

The charge condition of the battery or batteries is displayed in the "Feeding" function. The voltages are shown as bar graph on the right. The five squares in Row 1 (optional) indicate the charge condition for the propelling drive.

You can assess the battery charge condition here:

		
Charge battery now!	Battery ready for operation	Battery fully charged

Figure 6/4: Display of battery charge condition



CAUTION

CAUTION

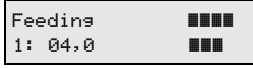
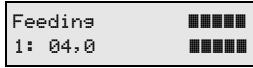
The device may not be operated if the charge condition is insufficient (battery voltage less than 12 V). This could otherwise damage the battery!

For **temperatures below 0°C**, charge the battery sooner (at 12.2 V and less).

6.4 Cleaning

The Milk Shuttle must be cleaned after every use in order to clean the container and the conveying system:



CAUTION

CAUTION

It must be ensured that cleaning is **never started when the feed container is empty**.

This could otherwise damage the heater, the mixer and the dosing pump!

6.4.1 Milk Shuttle without dosing pump

1. Roughly wash off the inside of the container and the agitator with cold water.
2. Let the water drain.
3. Refill with water until it has covered half of the agitator propeller. If necessary, add detergent:
 - for whole milk feeding for every 4th cleaning
 - for calf milk replacer (CMR) feeding for every 6th cleaning

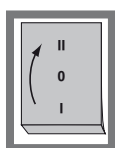

4. Let the water heat by pressing and holding the  key to start heating and agitation. Once the required temperature is reached:

5. Switch the agitator to Level II (fast mode) and press and hold the  key on the operating panel to start the agitator.





6. If strongly soiled:

- Switch off the agitator at the motor (switch at position "0")



- Interrupt the agitating interval using the  key on the operating panel
 - Use a brush to preliminarily clean the inside of the container
 - Switch the agitator back on (switch at position "2")
 - Press  to continue the agitating interval.
7. After completion of the long interval, allow water to drain off.
 8. Then rinse once or twice with clean water.

6.4.2 Milk Shuttle with dosing pump (optional)

The Milk Shuttle with the optional dosing pump has a cleaning program. Please note that cleaning with heating is only possible on mains operation.

Use the preselection keys ,  or  and select one of the three cleaning times.

When delivered, the preselection keys are assigned the following cleaning times:

Preselection key	Cleaning time
	2 min
	3 min
	5 min

How to program the preselection keys with your own values is described in *chapter 7.5, page 56*.

1. Fill a small amount of water (a few centimetres). Start the dosing pump and roughly clean the inside of the container with the pump nozzle.
2. Pump off the water.
3. Refill with water until it has covered half of the agitator propeller. If necessary, add detergent:
 - for whole milk feeding for every 4th cleaning
 - for CMR feeding for every 6th cleaning
4. Press the  key on the operating panel for approx. 2 seconds to switch on the control. The displays shows the start window:

16.07.14 10:30:32
 MilkShuttle 105A31
5. Press the  key for approx. 2 seconds to switch to the cleaning program.

6. The display image changes:

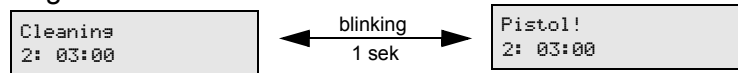

7. Press the trigger and fix it (see figure 6/3).
 8. Hang the pump nozzle in the wash device **1**. The cleaning program will not start if the pump nozzle is not engaged! Once the pump nozzle is engaged, the display image will stop alternating.

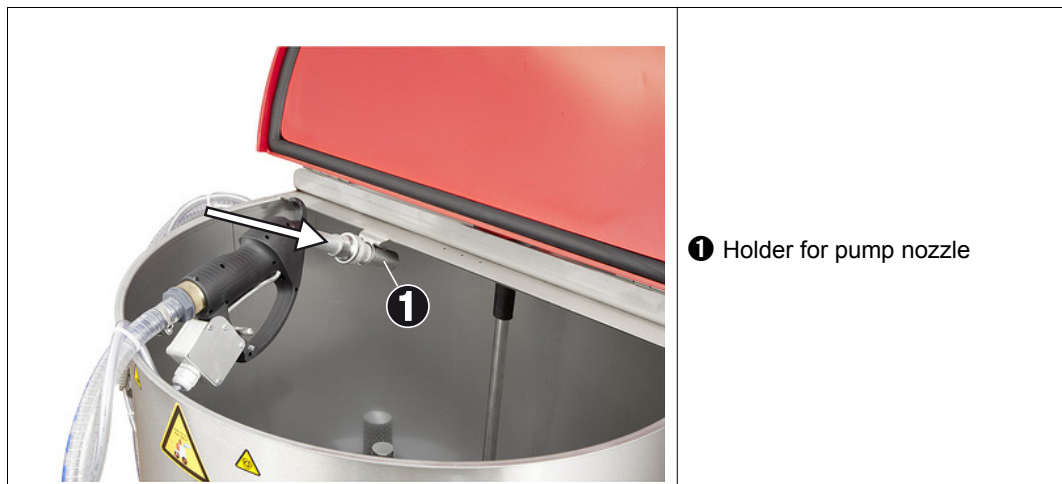
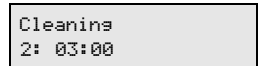



Figure 6/5: Pump nozzle during rinsing

9. Choose the required cleaning program **1**, **2** or **3**
 e. g. Cleaning Program 2 (3 min. rinsing duration):



10. Use the Δ / ∇ keys to individually change the running time of the pump without saving this value. Changing the running time deactivates the heating.

Briefly pressing the  key lets you cancel the function.

11. Press the  key to start the cleaning program. The heater heats the wash water to the set cleaning temperature. The pump only operates intermittently. The displays alternately shows information on cleaning and heating:

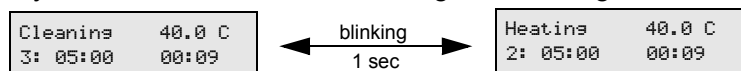

12. After 10 seconds, the display switches to the view of the actual temperature:

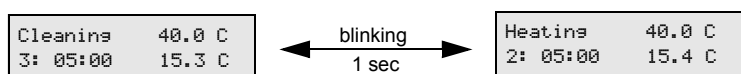

13. If you want to stop the cleaning program prematurely, you can press the  key again. The cleaning process will be interrupted and you are brought back to the "Cleaning" menu window.

6.5 Moving the MilkShuttle



WARNING

Danger of injuries caused by uncontrolled driving movements.

- Never fix the controllers in any kind of position.
- Ensure free movement of the controllers.
- In an emergency, press the safety stop button **2**. The Milk Shuttle stops immediately and then moves back a few centimetres.
- When the brake is released, secure the Milk Shuttle against rolling away!

6.5.1 Moving on level ground

The electric propelling drive makes it convenient to move the Milk Shuttle and will save your strength. To do so, carry out the following steps:

1. Disconnect the electrical connection from the device.
2. Select the required driving direction using one of the controllers **1** on the drawbar head.
 - Press controller down: Forwards driving direction (pull Milk Shuttle).

Press controller up: Backwards driving direction.



Information

Both controllers **1** have the same functions - you may use either the left or the right controller. When a controller is released, it returns automatically to the central position and the Milk Shuttle is braked until standstill.

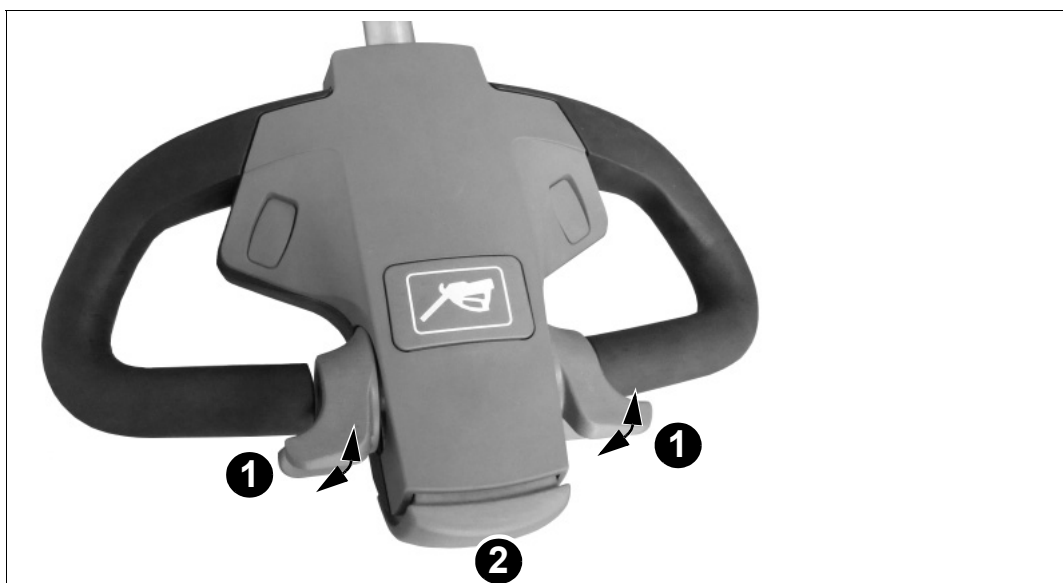

Figure 6/6: Drawbar head

3. Select the required driving speed by moving the controller **1**: The further you turn a controller in one direction, the faster the Milk Shuttle moves.

When the batteries are discharged, the Milk Shuttle can be moved by releasing the brake, as described in *chapter 4.4.4*. When the brake is released, secure the Milk Shuttle against rolling away!

6.5.2 Moving the MilkShuttle on sloping terrain



WARNING

WARNING

For sloping terrain (more than 3 % slope), danger of being run over.

- Walk behind the device (against the direction of travel, see figure 6/7).
- Grasp the drawbar handle with both hands.
- Comply with permitted transport volume (see *chapter 3*).
- Do not travel along routes with slopes of more than 10 %!
- Do not drive over steps higher than 4 cm.

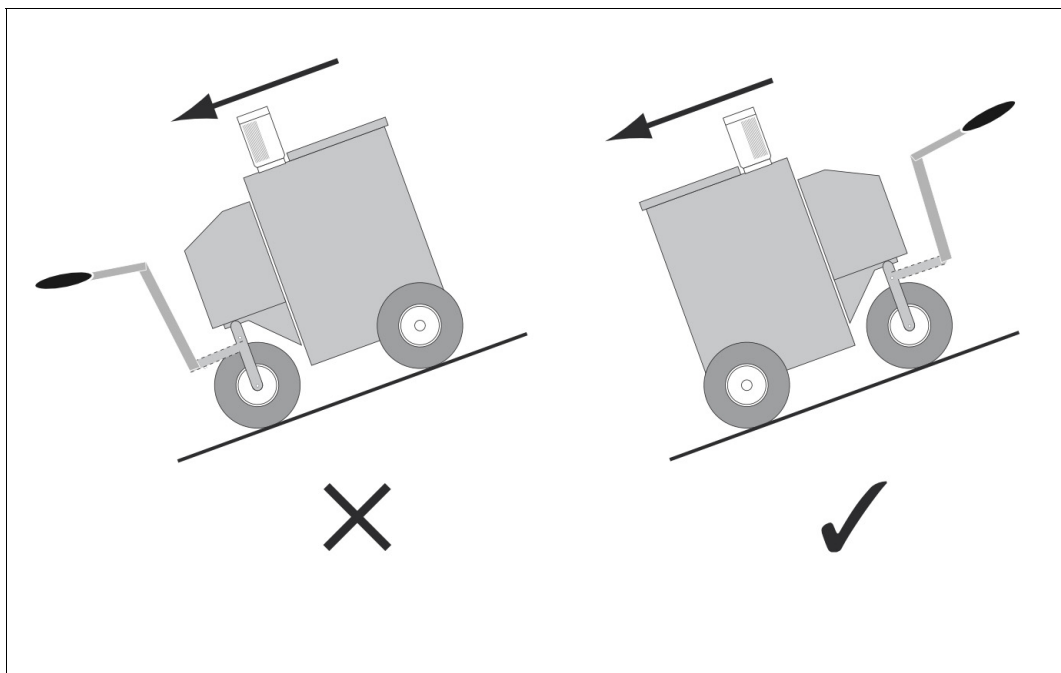

Figure 6/7: Moving on slopes

7 Programming and calibrating

7.1 General settings



INFO

Information

In this chapter you will use the programming mode.

You can recognize this programming mode in that the values to be programmed (the warning temperature here), are set in angle brackets:

```
Temp. Warning level
max    > 45.0 C<
```

Switch on the Milk Shuttle with the  key (approx. 2 seconds).

The device is in standby mode and shows the start display:

```
16.07.14  10:30:32
MilkShuttle  105A31
```



The functions described in this chapter are accessed by pressing and

holding the  key.

In this menu you can change the settings for the

- Time
- Date
- Language
- Temperature unit and
- Temperature warning level

and have the serial numbers and version numbers displayed.

Use the  /  keys to scroll through the menus.

7.1.1 Setting the time and date



The clock must be changed manually from summertime to wintertime. The seconds cannot be set. To change the time and date, carry out the following steps:

1. Press the  key for approx. 2 seconds. The display shows the date and time:



```
Date      Time
08.04.14  10:30:32
```





2. Briefly press the  key:



```
Time      hh.mm.ss
>10<30:32
```

3. Use  /  to change the hours.

4. Use  to put the minutes into programming mode:

Time hh.mm.ss
 10>30<32
5. Use  /  to change the minutes.
6. Use  to change the date:



Date dd.mm.yy
 >08<04.14
7. Use  /  to change the day, press again briefly  and set the month with  /  :

Date dd.mm.yy
 08>04<14
8. Briefly press  again and use  /  to set the year:



Date dd.mm.yy
 08.04>14<
9. Pressing this key  will take you from any level back to the top.

7.1.2 Setting the user language

The language shown in the display is set to the language of your country before the device is delivered. You may change the user language at any time. However, your choice of languages is restricted to the languages that are available inside the language pack of your MilkShuttle (see chapter 4.3, page 16). In order to switch to a different language, carry out the following steps:

1. Press the  key for approx. 2 seconds.
2. Use  to select the "Language" function:

Language
 Englisch
3. Press  to switch to the programming mode:



Language
 >Englisch<
4. Press  /  to select the required language, e.g. *Deutsch* (= German):

Sprache
 >Deutsch<
5. Confirm with  :

Sprache
 Deutsch



7.1.3 Changing the temperature unit (Celsius or Fahrenheit)

To change the displayed temperature unit, carry out the following steps:

1. Press the  key for approx. 2 seconds.
2. Use  to select the "Temperature" function:

Temperature
 Celsius
3. Press  to switch to the programming mode:

Temperature
 >Celsius<



- Press  /  to select the required unit, e.g. Fahrenheit:

```
Temperature
>Fahrenheit<
```



- Confirm with . The temperature values are now shown in the respectively other unit.

7.1.4 Setting the warning levels for minimum and maximum temperature



The following settings enable you to set two warning levels when exceeding or dropping below certain temperature levels. When the set feeding temperature (e.g. 42°C) is exceeded or drops below the value, a message is shown on the display and feeding is stopped. You can start or stop the heater, as necessary. To set these warning levels, carry out the following steps:

- Press the  key for approx. 2 seconds.
- Use  to select the "Temperature warning level minimum" function:



```
Temp. Warning level
min    ---.- C
```

- Press  to switch to the programming mode:
- The device suggests a warning level of 35°C which you can change to the required warning temperature by using  / .

```
Temp. Warning level
min    > 35.0 C<
```

- Confirm with .
- Press  to continue to the function "Temperature warning level maximum":

```
Temp. Warning level
max    ---.- C
```

- Press  to switch to the programming mode:
- The device suggests a warning level of 45°C which you can change to the required warning temperature by using  / .

```
Temp. Warning level
max    > 45.0 C<
```

- Confirm with .
- You can delete the warning levels by entering a temperature less than 10°C or greater than 55°C. The warning level then converts to dashes in the display:







```
Temp. Warning level
max    >---.- C<
```

- Press the  key to confirm the deletion.

7.1.5 Display Version and serial numbers

These menus will display the version or serial numbers of the individual modules that are needed, e.g., as information for a service technician. To display the







version number, carry out the following steps:

1. Press the  key for approx. 2 seconds.
2. Use  to select the "Version number" function:
3. Press  to switch to the display mode:
4. Press  /  to display the individual modules.
5. Press the  key to exit the "Version numbers" menu.

```
Version No.
```

```
Version No.      DIMA  
1.20
```

To display the serial number, carry out the following steps:

1. Briefly press the  key (approx. 1 second).
2. Use  to select the "Serial number" function:
3. Press  to switch to the display mode:
4. Press  /  to display the individual modules.
5. Press the  key to exit the "Serial numbers" menu.

```
Serial No.
```

```
Serial No.      DIMA  
BC4EC52E 06072273
```

7.2 Calibration



Switch on the Milk Shuttle with the  key (approx. 2 seconds).

The "Calibrate" menu is accessed from the main menu:

```
16.07.14  10:30:32  
MilkShuttle  105A31
```

Hold down the  key for approx. 2 seconds.

This menu lets you adjust the pump and the temperature. The Milk Shuttle can be calibrated either in mains or in battery mode.

After pressing the  key, the LED of this key flashes. The last used calibration menu is called up. Use the keys  or  to call up the menu "Calibrate pump" or "Calibrate temperature" respectively.

7.2.1 Calibrate pump (time-controlled)

When calibrating the "SET pump" function, feed is conveyed for 5 seconds. The conveyed amount is measured by the user and entered in the control.

To do so, carry out the following steps:

1. Hold down the  key for approx. 2 seconds:
2. Actuate the pump nozzle over a collecting tray until the feed pump stops automatically. Hold the pump nozzle **at the same height as when dosing later on** to achieve the greatest possible precision.
3. Measure the conveyed feed amount.







1: PUMP 03.500



INFO

Information

You can measure the feed amount alternatively in kg or in litres. The chosen unit (litre or kilogram) must then be used when entering the delivered volume or mass.

4. Press the  key approx. 2 seconds.
5. Use  /  to enter the measured feed amount (e.g. 3.3 litres)
6. Briefly press  to exit the calibrate settings.
7. Briefly press  or  to exit the calibrate menu.

SET PUMP >03.500<

SET PUMP >03.300<



INFO

Information

The precision of the time-controlled dosing depends on several factors, e.g.:

- Charge condition of the battery
- Fill level of feed container
- Height of pump nozzle
- Ambient temperature

An even greater precision is achieved if the MilkShuttle will be equipped with an (optionally available) flow rate meter (hardware).

7.2.2 Calibrate the pump with the flow rate controller (optional)

When calibrating the "SET pump" function, feed is conveyed for approx. 5 seconds. During this time, the flow rate controller counts the number of pulses. The conveyed amount is measured by the user and entered in the control.

To do so, carry out the following steps:

1. Hold down the  key for approx. 2 seconds:

1: Pump	03.200
	168
2. Actuate the pump nozzle over a collecting tray until the feed pump stops automatically. Hold the pump nozzle **at the same height as when dosing later on** to achieve the greatest possible precision.
3. After the dosing duration of 5 seconds, the display shows the view opposite:

1: Pump	03.200
167	168



The left value shows the measured value of the current measurement, the right value is the calibration value used for calculation.
4. Measure the conveyed feed amount.





INFO

Information

You can measure the feed amount alternatively in kg or in litres. The chosen unit (kg or litre) must then be used when entering the required volumetric delivery.

5. Press the  key approx. 2 seconds.
6. Use  /  to enter the measured feed amount (e.g. 3.3 litres)



SET Pump	>03.200<
167	168
7. Briefly press  to exit the calibrate settings:

SET Pump	>03.300<
167	168
8. Briefly press  or  to exit the calibrate menu.

7.2.3 Temperature calibration





The temperature regulation of the Milk Shuttle is calibrated precisely before the device leaves the factory. Recalibration is only then necessary if the true temperature of the feed deviates from the displayed actual temperature.

To do so, carry out the following steps:

1. Hold down the  key for approx. 2 seconds.
2. Briefly press the  key:

2: Temperature	
14.5 C	+0.0
3. Use a thermometer to measure the deviation of the feed temperature from the target temperature.

4. Hold down the  key for approx. 2 seconds:

SET Temperature
 14.5 C >+0.0<
 5. Press  /  to change the displayed correction value by the measured deviation.
 6. Briefly press  to exit the programming mode.
- Use the  key to exit the temperature calibration.

7.3 Programming heating and agitating

7.3.1 Overview

The heater installed in the Milk Shuttle heats the feed in the container to the required temperature (target temperature). The heater switches off as soon as the target temperature is reached. Due to the inertia of thermal systems, the actual temperature will temporarily exceed the target temperature.

The agitator ensures an even temperature distribution in the feed. The operating and break times of the agitator should be adapted to the type of feed that is used. The following table shows field-proven values:

	Slow mode (Level I)	Fast mode (Level II)	Operating time	Break time
Calf milk replacer (CMR)		✓	3 s	4 min
	✓		10 s	1:30 min
Whole milk	✓		10 s	1:30 min



INFO

Information

If residues develop along the bottom of the container:

- increase the operating time, and/or
- shorten the break time



INFO

Information

In this chapter you will use the programming mode.

You can recognize this programming mode in that the values to be programmed (the warning temperature here), are set in angle brackets:

Temp. Warning level
 max > 45.0 C<

Switch on the Milk Shuttle with the  key (approx. 2 seconds).

The "Heating and Agitating" menu is accessed from the main menu:

```
16.07.14  10:30:32
MilkShuttle  105A31
```

Hold down the  key for approx. 2 seconds.

7.3.2 Operating values

Three values can be programmed in the heater control:

- Target temperature of the heater
- Operating time of the mixer
- Break time of the mixer

The following values are preset when delivered:

- Target temperature: 40 °C
- Agitating: 10 seconds
- Break: 15 seconds

The following example describes how to program with values:

- Target temperature: 38 °C
- Agitating: 20 seconds
- Break: 45 seconds

To do so, carry out the following steps:

1. Hold down the  key for approx. 2 seconds.
2. If no start times are programmed, you will briefly see this display:

```
1:Automatic Heating
1:--:-- active
```

The display then switches automatically:

```
Heating  Agitating
16.3 C   00:28
```

blinking
1 sec



```
40.0 C Break
16.3 C 00:28
```

3. Press  to switch to the programming mode:

```
SET Target
40.0 C
```

4. Press the  key again:

```
SET Target
> 40.0 C<
```

5. Press  /  to set the required target amount (38 °C):

```
SET Target
> 38.0 C<
```

6. Briefly press the  key.



```
SET Target
38.0 C
```

7. To adjust the time for **agitating**, press the  key:

```
SET Asitating
00:10
```

8. Press the  key:

```
SET Asitating
>00:10<
```

9. Use  /  to set the required agitating time (20 sec.):

```
SET Asitating
>00:20<
```

10. Briefly press the  key.



```
SET Asitating
00:20
```

11. To adjust the **break time**, press the  key:

```
SET Break
00:15
```

12. Press the  key:

```
SET Break
>00:15<
```

13. Press  /  to set the required break time (30 seconds):



```
SET Break
>00:30<
```

14. Briefly press the  key.

```
SET Break
00:30
```

You can cancel the changes to the values at any time with the  key.

7.3.3 Programming the start times

In this menu you can pre-program the start times. Each pre-selection key ,  and  can have 2 start times assigned, one for feeding in the morning and one for feeding in the evening. The Milk Shuttle automatically starts heating and agitating at the specified time. This omits waiting times until the feed has been heated.



CAUTION

CAUTION

After creating/changing the start times, you must make sure that the power supply is **never switched on when the feed container is empty**.

This could otherwise damage the heater and the agitator!

Carry out the following steps to program the start times:

1. Switch on the Milk Shuttle with the  key.

The device is in standby mode and the start display is shown:

```
00.04.14 10:30:32
MilkShuttle 105A31
```

2. Press the  key for approx. 2 seconds. If no start time is programmed, the device automatically begins with heating and agitating.

In the display, the view switches to:

```
Heating  Asitating  ← blinking →  Heating  Break
16.3 C   00:28      1 sec      16.3 C   00:28
```



3. Press  (approx. 2 seconds) to switch to the programming mode.

4. Press  to switch to the "SET Start time 1" display:

```
SET Start time 1
--:--  --:--
```



5. Briefly press the  key again:

```
SET Start time 1
>--<--  --:--
```

6. Press  /  to set the required start time (hours) for mornings:

```
SET Start time 1
>07<00  --:--
```



7. Briefly press the  key again.

8. Press  /  to set the required start time (minutes) for mornings:

```
SET Start time 1
07>00<  --:--
```



9. Briefly press the  key again.

```
SET Start time 1
07>00<  >--<--
```

10. Press  /  to set the required start time (hours) for evenings:

```
SET Start time 1
07:00  >15<00
```

11. Briefly press the  key again.

12. Press  /  to set the required start time (minutes) for evenings:

```
SET Start time 1
07:00  15>30<
```

13. Press  briefly again to exit the programming mode.



```
SET Start time 1
07:00  15:30
```

Start times 2 and 3 can be programmed accordingly.



7.3.4 Deleting the start times

You can **delete** the programmed start times as follows:



1. Use the  key to move to the start time to be deleted.

2. Use  /  to set the hours to "00".

3. Briefly press the  key.

4. Use  /  to set the minutes to "00".

5. Press  once; "--:--" is displayed.

6. Exit the menu with  or .

7.4 Programming feeding



INFO

Information

In this chapter you will use the programming mode.

You can recognize this programming mode in that the values to be programmed (the warning temperature here), are set in angle brackets:

```
Temp. Warning level
max > 45.0 C<
```

The preselection keys **1**, **2** and **3** can be programmed with frequently used feed amounts.

Switch on the Milk Shuttle with the  key (approx. 2 seconds).

The "Feeding" menu is accessed from the main menu:

```
15.07.14 10:30:32
MilkShuttle 105A31
```

Hold down the  key for approx. 2 seconds.

After pressing the  key (approx. 2 seconds), the LED of this key flashes. The last used feeding menu is called up.



INFO

Information

After starting up, the pump must be first calibrated to the required unit (litre or kilogram) (see *chapter 7.2 on page 48*).

The factory settings for the delivered quantities are as follows:

- Key 1: 2.0 l (or kg)
- Key 2: 3.0 l (or kg)
- Key 3: 4.0 l (or kg)

In the following example, the preselection key **2** is programmed so that 3.5 l (or kg) feed are conveyed:



1. Hold down the  key for approx. 2 seconds.

2. Briefly press the **2** key:

```
Feeding
2: 03.0 ■■■■
```

3. Press  (approx. 1 second) to switch to the programming mode:

```
SET Feeding
2: >03.0<
```

4. Press  /  to set the required feed amount (here: 3.5 l (or kg)):



```
SET Feeding
2: >03.5<
```

5. Briefly press the  key.

6. This assigns the preselection key  a feed amount of 3.5 l (or kg) and ends the programming mode.

Use the  key to exit the programming of the feed amount.

7.5 Programming the cleaning programs

The preselection keys ,  and  can be programmed with frequently required cleaning times. One can either programme simple or extended cleaning programs. With extended cleaning, the rinsing phase is preceded by a heating phase. While simple cleaning is possible both in mains and in battery mode, the extended cleaning (with pre-heating function) is only possible in mains operation.

Switch on the Milk Shuttle with the  key (approx. 2 seconds).

The "Cleaning" menu is accessed from the main menu:

```
15.07.14 10:30:32
MilkShuttle 105A31
```

Hold down the  key for approx. 2 seconds.

After pressing the  key, the LED of this key flashes. The last used cleaning menu is called up.

The factory settings for the cleaning times are as follows:

- Key 1: 2 minutes
- Key 2: 3 minutes
- Key 3: 5 minutes



In the following example, the preselection key  is programmed for a cleaning time of 4 minutes:



1. Hold down the  key for approx. 2 seconds.

2. Briefly press the  key:

```
Cleaning
1: 02:00
```



3. Press  (approx. 1 second) to switch to the programming mode:

SET Cleaning
 1: >02:00< ----.- C
4. Press  /  to set the required duration of the cleaning program (here: 4 minutes):



SET Cleaning
 1: >04:00< ----.- C
5. Briefly press the  key and use the  /  keys to set the required temperature:



SET Cleaning
 1: 04:00 >----.- C<
6. Briefly press the  key.
7. This assigns the preselection key 1 a cleaning time of 4 minutes and ends the programming mode.

In the following example, the preselection key 3 is programmed for a cleaning time of 5 minutes and the extended cleaning incl. heating. Please note that heating only works during mains operation.

1. Hold down the  key for approx. 2 seconds.
2. Briefly press the 3 key:

Cleanins 40.0 C
 3: 05:00 25.3 C
3. Press  (approx. 2 seconds) to switch to the programming mode:

SET Cleaning
 3: >05:00< 40.0 C
4. Use  /  to set the required cleaning duration (4 min.):

SET Cleaning
 3: 04:00 > 40.0 C<
5. Briefly press the  key:
6. Press  /  to select the heating temperature:

SET Cleaning
 3: 04:00 > 42.0 C<
7. Confirm the entry by briefly pressing the  key.

8 What if...

8.1 General errors

Description	Possible causes	Remedy
Agitator runs untrue/rattles	Bearing bushing worn out	Replace wearing part set (Order No. 230.201) (see chapter 10)
Nothing in the display	Device not switched on/in power saving mode	Press "ON" button at operating panel for 2 seconds.
	No mains voltage available	Connect power supply (see chapter 5.5)
	Fuse defective (F1 10A 12 V, for devices with dosing pump)	Replace fuse (see chapter 9.2)
	Battery defective	Replace battery
	Display defective	Call Customer Service
Date and time displayed incorrectly	Circuit board battery is defective	Replace battery (see chapter 9.3)
Heater does not work although actual temperature < target temperature	Triac defective	Call Customer Service
	Module AC 230L31 (heating control) defective	Call Customer Service
Agitator does not work	Switch in centre position	Turn switch to position I or II
	Defective fuse in module AC 230L31 (6.3 A)	Replace fuse (see chapter 9.2)
	Motor defective	Call Customer Service
	Module AC 230L31 defective	Call Customer Service
Battery does not charge completely	Charging time too short	Leave device connected to the power supply for a longer period
	Battery defective	Call Customer Service
	Charger defective	Call Customer Service
Propelling drive without function	Power management function	Switch device on and off with "ON" button at display
	Power plug is connected	Disconnect the power plug
	Release from control blocked due to overload	Switch device on and off with "ON" button at display
	Drive release fuse triggered	Replace drive release fuse
	Safety cutout triggered	Switch safety cutout back on (see chapter 9.2)
	Controller defective	Call Customer Service
Propelling drive drives with low performance	Overload	Let Milk Shuttle stand for 15 min. to cool down

8.2 Display messages

In order to more quickly recognise and remedy occurring Milk Shuttle II faults, the electronics have been equipped with monitoring units.

There are three types of fault messages:



1. **The red LED INFO flashes:**

The red LED in the key flashes for messages that affect the system. These messages affect the functions of the Milk Shuttle II, but the device can still execute the function in general. Press the key to display the message.

For example: A 230 V fuse is defective. The Milk Shuttle II can still heat if it has been equipped with double heaters.



2. **The red LED INFO flashes and a message appears directly in the display:**

The red LED in the key flashes and a message appears directly in the display if the function cannot be executed and the user must eliminate the message.

For example: While "Heating/Agitating" you discover that there is no liquid in the feed container. Fill the Milk Shuttle II with water or milk and acknowledge the message.

3. **The message appears directly in the display and flashes alternately with the function text:** This message appears if the function

- is not currently being executed or
- will not be executable soon.

The message is eliminated after performing control measurements or if you eliminate the message. For example: While "Feeding" you discover that the battery is weak. The device still functions, but you should connect it as quickly as possible to the mains voltage for charging.

A message consists of two digits and text. Based on the two digits – the fault code – it is possible to localise the message. But always consider the text as well.

The following tables list the explanations to the individual messages. These messages are displayed in this form as of version 1.05. There may be small deviations for older versions.

- Column 1: The fault code at top and the type of fault message below (1, 2 or 3).
- Column 2: Message shown on the display
- Column 3: Fault description
- Column 4: Possibilities for fault elimination.

No. Type	Display message	Fault description	Troubleshooting		
11 1	11 Fault AC1 No mains voltage	There is no mains voltage present at the circuit board(s) for heating control (boards 1 or 2). AC1 ⇒ circuit board with address 1 assigned (type AC230L31) is affected AC2 ⇒ circuit board with address 2 assigned (type AC230L31) is affected	<ul style="list-style-type: none"> • Check the supply lead for damage. • Check the fuse in the electric installation. • Check the micro-fuse located on the circuit board for heating control 1 or 2 and replace as necessary (see chapter 9.2). 		
12 1	12 Fault AC2 No mains voltage			15 1	15 Fault AC1 TF
16 1	16 Fault AC2 TF	AC2 ⇒ thermal fuse of heating element 2 is affected	<ul style="list-style-type: none"> • Replace the thermal fuse of heating element 2 		
18 1	18 Fault AC4 TF		AC4 ⇒ thermal fuses of both heating elements are defective	<ul style="list-style-type: none"> • Replace the thermal fuses of both heating elements 1 and 2 	

No. Type	Display message	Fault description	Troubleshooting
21 1	Fault Temperature 22.9 199.0 52.3 a	Depending on the fault code, either one or several temperature sensors are not connected or have an open cable break.	<ul style="list-style-type: none"> Connect or replace temperature sensor of heating element 1 (connected to left heating control circuit board with address 1 assigned)
22 1	Fault Temperature 22.9 48.4 199.0	The numerical code 199 in the second line of the message indicates which temperature sensor is defective.	<ul style="list-style-type: none"> Connect or replace temperature sensor of heating element 2 (connected to right heating control circuit board with address 2 assigned)
23 1	Fault Temperature 22.9 199.0 199.0	199.0 199.0 199.0 DIMA AC1 AC2	<ul style="list-style-type: none"> Connect or replace temperature sensors of both heating elements 1 and 2
24 1	Fault Temperature 199.0 48.4 52.3	AC1 ⇒ circuit board for heating control with address 1 assigned (left board, type AC230L31)	<ul style="list-style-type: none"> Connect or replace temperature sensor of medium in container (connected to central control circuit board DIMA220)
25 1	Fault Temperature 199.0 199.0 52.3	AC2 ⇒ circuit board for heating control with address 2 assigned (right board, type AC230L31)	<ul style="list-style-type: none"> Connect or replace both the temperature sensor of the medium and the temperature sensor of heating element 1
26 1	Fault Temperature 199.0 48.4 199.0	DIMA ⇒ circuit board for central control (module DIMA220)	<ul style="list-style-type: none"> Connect or replace both the temperature sensor of the medium and the temperature sensor of heating element 2
27 1	Fault Temperature 199.0 199.0 199.0		<ul style="list-style-type: none"> Connect or replace both the temperature sensor of the medium and the temperature sensors of both heating elements (1+2)

No. Type	Display message	Fault description	Troubleshooting
31 1	31 Fault Temperature 22.9 198.0 52.3	Temperature sensor has a cable break with short-circuit.	<ul style="list-style-type: none"> Replace temperature sensor of heating element 1 (connected to left heating control circuit board with address 1 assigned)
32 1	32 Fault Temperature 22.9 48.4 198.0	The numerical code 198 in the second line of the message indicates which temperature sensor is defective.	<ul style="list-style-type: none"> Replace temperature sensor of heating element 2 (connected to right heating control circuit board with address 2)
33 1	33 Fault Temperature 22.9 198.0 198.0	198.0 198.0 198.0 DIMA AC1 AC2	<ul style="list-style-type: none"> Replace temperature sensors of both heating elements 1 and 2
34 1	34 Fault Temperature 198.0 48.4 52.3	AC1 ⇒ circuit board for heating control with address 1 assigned (left board, type AC230L31)	<ul style="list-style-type: none"> Replace temperature sensor of medium in container (connected to central control circuit board DIMA220)
35 1	35 Fault Temperature 198.0 198.0 52.3	AC2 ⇒ circuit board for heating control with address 2 assigned (right board, type AC230L31)	<ul style="list-style-type: none"> Replace both the temperature sensor of the medium and the temperature sensor of heating element 1
36 1	36 Fault Temperature 198.0 48.4 198.0	DIMA ⇒ circuit board for central control (module DIMA220)	<ul style="list-style-type: none"> Replace both the temperature sensor of the medium and the temperature sensor of heating element 2
37 1	37 Fault Temperature 198.0 198.0 198.0		<ul style="list-style-type: none"> Replace both the temperature sensor of the medium and the temperature sensors of both heating elements (1+2)

No. Type	Display message	Fault description	Troubleshooting
41 1	41 Fault Battery 10.4 U 00.0 U	Battery 1 and/or 2 does not have enough voltage. The charger is not charging. Tip: Remove the battery and charge with a non-electronic charger. This potentially can revive the battery for a short period.	<ul style="list-style-type: none"> • Replace battery 1. • Check battery charger 1.
42 1	42 Fault Battery 12.2 U 20.9 U		<ul style="list-style-type: none"> • Replace battery 2. • Check battery charger 2.
43 1	43 Fault Battery 10.4 U 20.9 U		<ul style="list-style-type: none"> • Replace batteries 1 and 2. • Check chargers 1 and 2.

No. Type	Display message	Fault description	Troubleshooting	
50 2	50 Fault Low milk level	Fault messages with the fault code 50 to 52 indicate insufficient heat dissipation from the MilkShuttle's container base. In this case, the central control stops the MilkShuttle from operating in order to prevent the heating element from overheating.	<p>When this fault appears the fill level of the MilkShuttle container needs to be checked:</p> <ul style="list-style-type: none"> • If the filling quantity in the MilkShuttle container is below the minimum fill level, fill the container with milk or water until the minimum fill level has been reached. • If the fill quantity in the MilkShuttle container is above the minimum fill level: <ul style="list-style-type: none"> • switch on the agitator in order to mix the liquid in the container and thereby create even heat dissipation inside the container. • check that the agitator is functioning properly. <p>If this fault repeatedly occurs it may be appropriate to set the tolerance barrier against low fill level of the container to the value <i>high</i>.</p>	
51 2	51 Fault Low milk level			
52 2	52 Fault Low milk level			

No. Type	Display message	Fault description	Troubleshooting
60 2	60 Fault No mains voltage	Function cannot be executed because there is no mains voltage present.	<ul style="list-style-type: none"> • Insert the power plug. • Check the fuses and the residual current device of the electric installation • Assure the clockwise phase sequencing of the electrical rotary field. In case of an anti-clockwise phase sequencing, switch the phases L1 and L2 by means of the phase changing switch of the connecting cable • Assure that the mains voltage is neither too low nor too high.
70 3	70 Battery low!	The battery voltage is weakening. Battery 1 under 12.2 V and/or Battery 2 under 24.4 V	<ul style="list-style-type: none"> • Connect Milk Shuttle II to mains voltage for charging as soon as possible.
72 3	72 Sensor faulty?	While dosing, the flow meter did not transmit a pulse during the last 5 seconds. The Milk Shuttle II is empty, or the flow meter is contaminated and is thus not measuring correctly.	<ul style="list-style-type: none"> • Fill Milk Shuttle II. • Rinse Milk Shuttle II with detergent. • Clean flow rate controller by hand. • If nothing changes after cleaning, deactivate the flow rate controller: Call up the "Feed" function and then press both "Plus" and "Minus" keys at the same time. "Flow r. controller deactivated" appears briefly in the display. When the flow rate controller is deactivated, the Milk Shuttle II works according to time dosing. After changing to time dosing, calibrate the Milk Shuttle II (see chapter 7.2.1). • Activating the flow rate controller is also done by pressing both "Plus" and "Minus" keys at the same time in the "Feed" function.

No. Type	Display message	Fault description	Troubleshooting
73 3	73 PUMP???	The pump is consuming too much power and the control output for the pump is shut off. Error message 81 also appears, see Message 81 at Page 68.	<ul style="list-style-type: none"> • Press the "ESC/INFO" key to view Error 81. Press the "ESC/INFO" key again to reset the message.
74 3	74 Temperature min	The temperature of the medium in the MilkShuttle's container (milk, water) has fallen below the limit value set by the user. In this case, the dosing pump will not start in order to avoid dosing out milk that is too cold.	<ul style="list-style-type: none"> • Heat the medium (feed, water) until it exceeds the set minimum temperature. • Lower or delete the set minimum temperature limit for the medium (see chapter 7.1.4). • Add warm water or milk until the mixture reaches a temperature above the set minimum temperature.
75 3	75 Temperature max	The temperature of the medium in the MilkShuttle's container (milk, water) exceeded the limit value set by the user. In this case, the dosing pump will not start in order to avoid dosing out milk that is too hot.	<ul style="list-style-type: none"> • Increase or delete the set upper temperature limit of the medium (see chapter 7.1.4). • Allow the medium in the MilkShuttle to cool until it falls below the set upper temperature limit. • Add cold water or milk until the mixture falls below the set upper temperature limit.

No. Type	Display message	Fault description	Troubleshooting
81 1	81 Fault Pump???	<p>The pump is consuming too much power and the control output for the pump is shut off. Reset the error. After the reset the pump can be controlled again.</p> <p>There could be two reasons for the high power consumption:</p> <ul style="list-style-type: none"> • Sluggish pump due to dirt accumulation <p>or</p> <ul style="list-style-type: none"> • Cable damage or cable break in the cable to the pump 	<ul style="list-style-type: none"> • Press the "ESC/INFO" key to view Error 81. Press the "ESC/INFO" key again to reset the message. • Clean pump. • Repair cable damage or cable break.
82 1	82 Fault	Circuit board for portion dispensing control: too much power is being diverted over the switching output 2 or 3.	<ul style="list-style-type: none"> • Press the "ESC/INFO" key to view Error 82/83. Press the "ESC/INFO" key again to reset the message.
83 1	83 Fault		<ul style="list-style-type: none"> • If this message appears frequently, call Customer Service.

No. Type	Display message	Fault description	Troubleshooting
91 1	91 Fault Battery low!	Dosing pump operating has been attempted. However, the current voltage of battery 1 is too low (< 12.0 V) in order to start the pump (functionality available as of firmware version 1.06).	<ul style="list-style-type: none"> • Connect Milk Shuttle II to the mains voltage for charging immediately.
92 1	92 Fault Temperature	The medium in the MilkShuttle (milk, water) has a temperature of over 70 °C (= 158 °F). The dosing pump will not operate in order to prevent material damage or scalding (functionality available as of firmware version 1.06).	<ul style="list-style-type: none"> • Allow the medium in the MilkShuttle to cool to below 70 °C (158 °F). • Add cold milk or cold water until the medium has cooled to under 70 °C (158 °F).
93 1	93 Fault Battery low	The MilkShuttle is to be moved using the propelling drive. The current voltage of battery 1 is however too low to move the MilkShuttle. (functionality available as of firmware version 1.07).	<ul style="list-style-type: none"> • Plug the MilkShuttle's power connector into the mains power supply as soon as possible so that the nearly empty battery can be recharged. If the battery charge is insufficient to move the MilkShuttle to the nearest plug socket then the brake lever of the propelling drive (located at the gearbox underneath the container bottom) must be released in order to push the MilkShuttle to the nearest plug manually (see chapter 4.4.4).
94 1	94 Fault Battery low	The MilkShuttle is to be moved using the propelling drive. The current voltage of battery 2 is however too low to move the MilkShuttle. (functionality available as of firmware version 1.07).	

8.3 Determining the operating code

The operating code of the device is important information for the service technician. Determine the operating code **before** you call your service technician. Write down the information so that you have it to hand.

Directly after switching on the MilkShuttle the main screen appears together with the operating code. If you are in a sub-menu (feed, rinse) and would like to see the

operating code you must press the button  on the operating device once in order to get back to the main menu, then the operating code will be displayed (here 107A31):

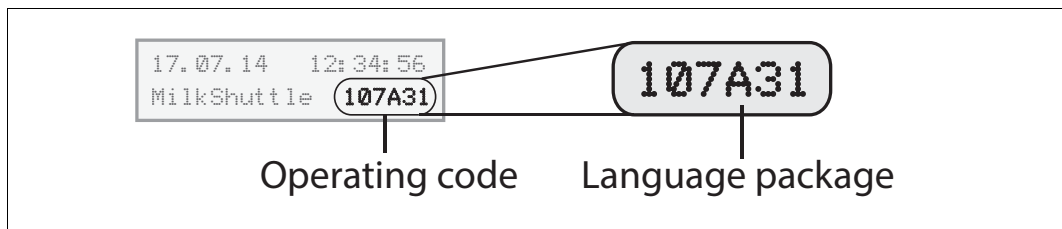

Figure 8/1: Operating code

You may determine the version of the language package of your MilkShuttle (see chapter 4.3, page 16) via the operating code: the fourth character of the operating code equals the version of the language package of your MilkShuttle firmware. In case of figure 8/1, the MilkShuttle model is equipped with language package A.

9 Maintenance/Repairs

9.1 Replace wearing part set

Required tools: Hexagon spanner 10 mm, sharp knife

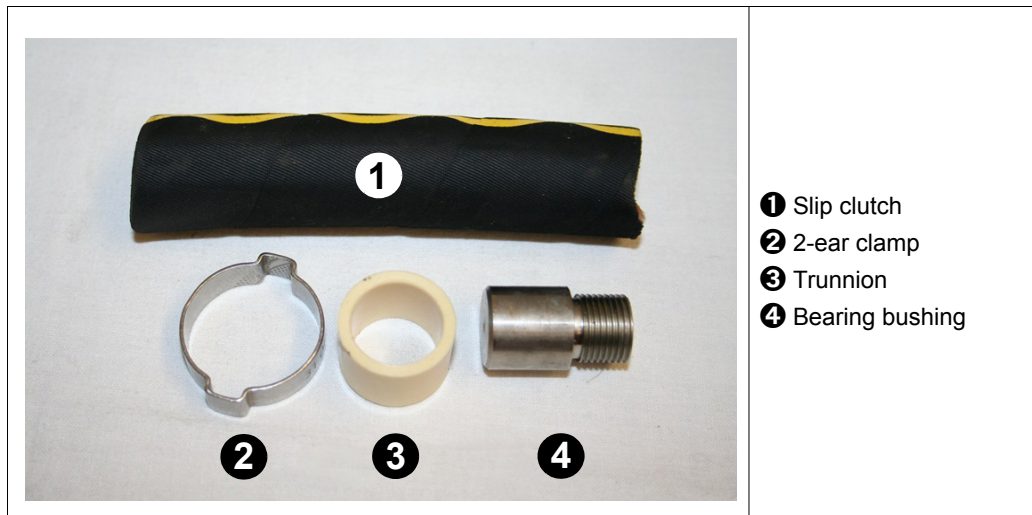

Figure 9/1: Wearing part set (Order No. 230.201)

You must replace the wearing part set if the agitator emits unusual noises or vibrates during operation.

To do so, carry out the following steps:

1. Open the flap of the feed container, cut the 2-ear clamp ❷ in two using a side cutter and remove the clamp from the shaft of the agitator.
2. Use a hexagon spanner (10 mm) to release the fastening screws of the motor:

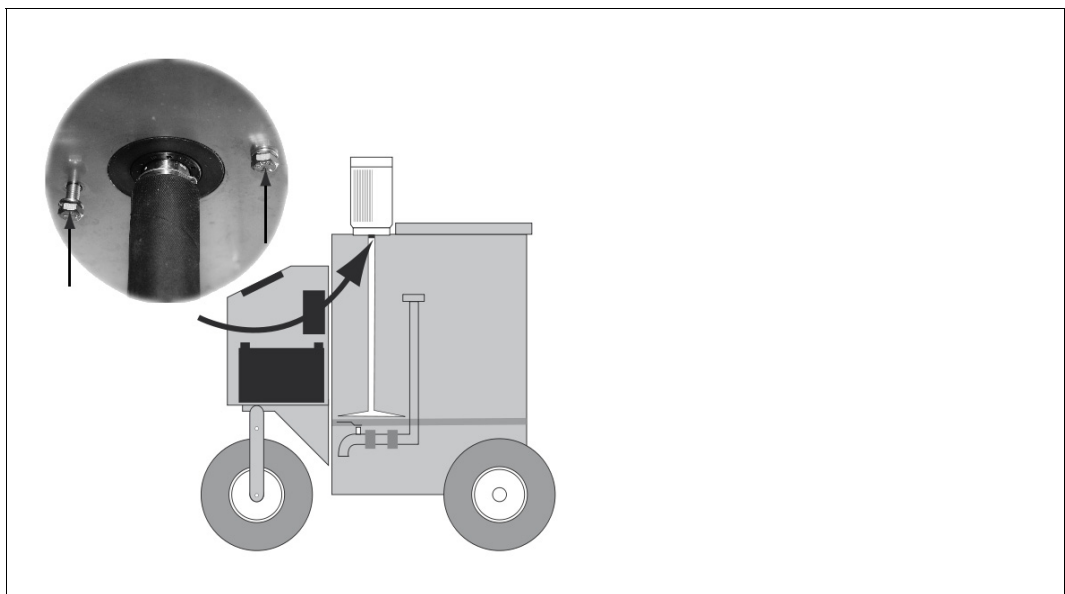

Figure 9/2: Fastening screws of the agitator motor

3. Lift up the motor slightly and lay it down at an angle:

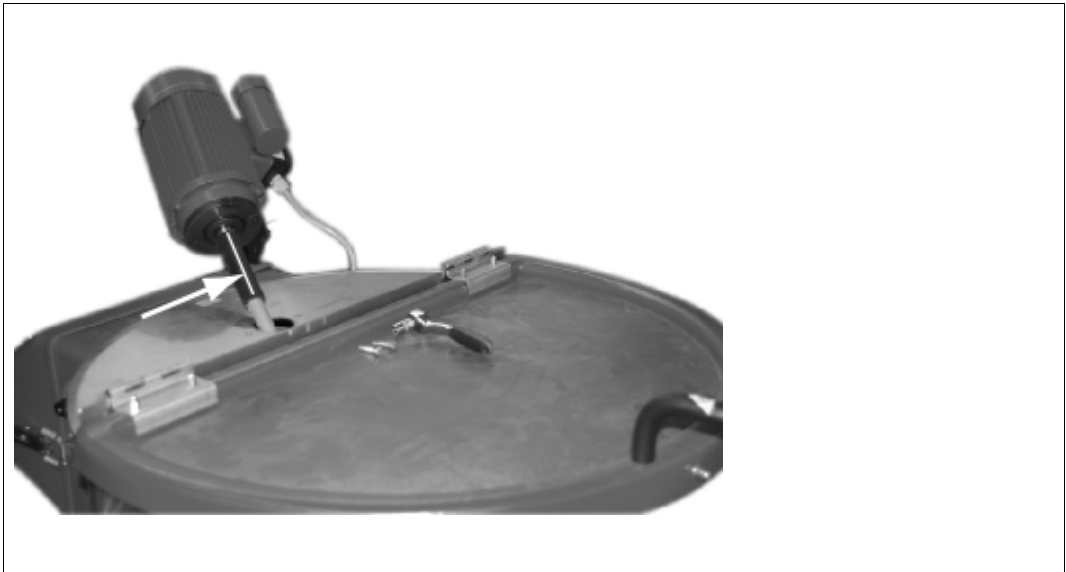

Figure 9/3: Remove slip clutch; remove motor

4. Cut open the slip clutch along the marked line (see *figure 9/3*) with a sharp knife.
5. Pull off the motor from the slip clutch and lay it down.
6. Pull off the slip clutch from the shaft of the agitator.
7. Pull the shaft of the agitator downwards out of the opening and remove it from the feed container.
8. Unscrew the trunnion from the shaft; screw on a new trunnion:

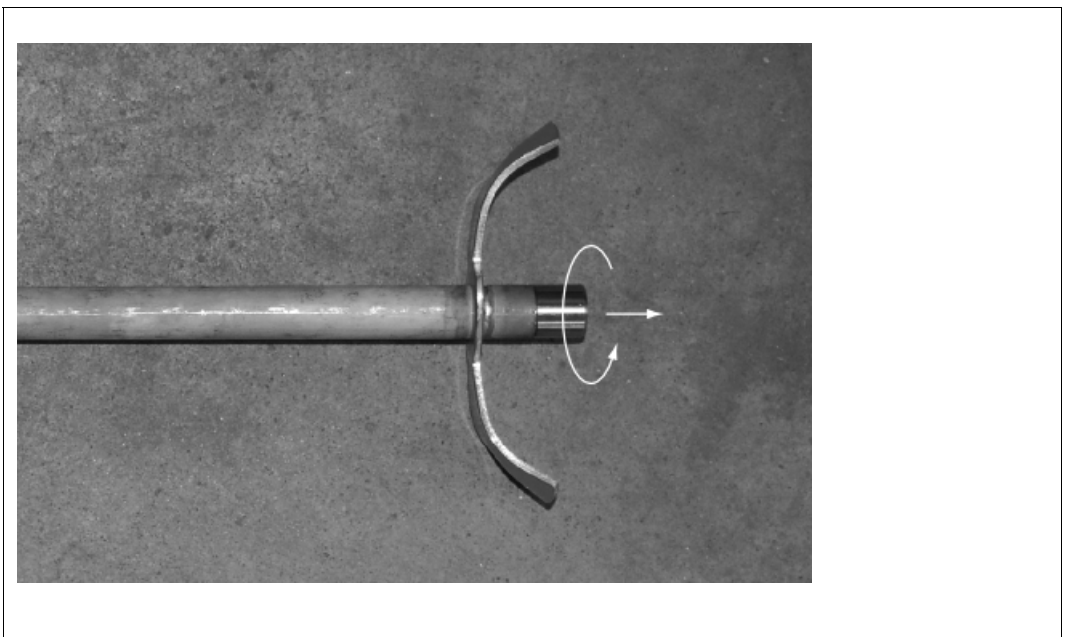

Figure 9/4: Unscrew the trunnion

9. Remove the bearing bushing from the bottom of the feed container; insert a new bearing bushing.

10. Degrease the other end of the motor shaft with an appropriate solvent.
11. Pull on a new slip clutch over the top end of the shaft. **Do not use any lubricant!**

The slip clutch fits very tightly on the shaft. Hitting the end of the shaft with the slip clutch on solid ground firmly several times will help push on the slip clutch. The slip clutch is pulled on until it ends approx. 2 - 3 mm below the container lid when tentatively installing the shaft:

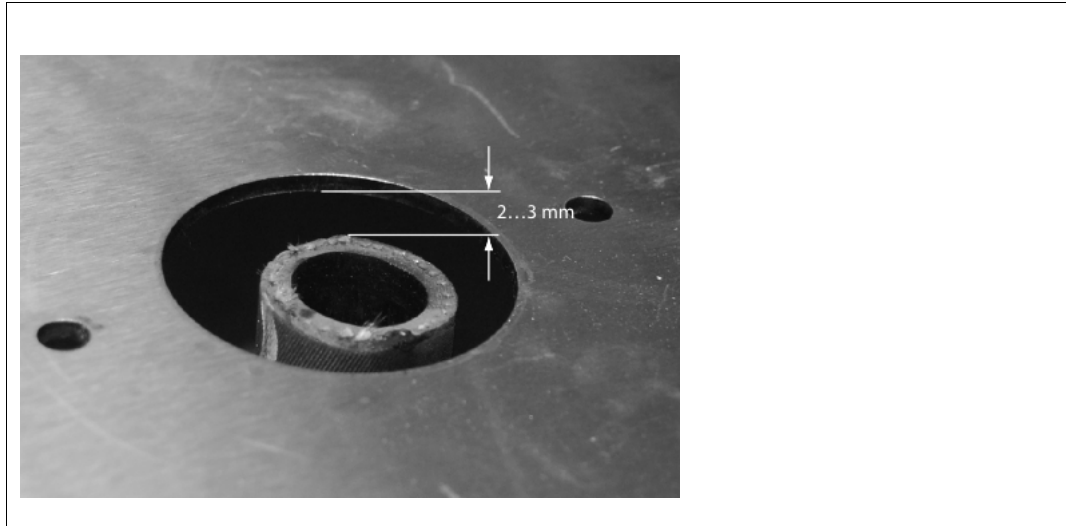

Figure 9/5: Adapting the slip clutch

12. Position the 2-ear clamp on the outside of the slip clutch.
13. Insert the shaft with the slip clutch.
14. Position the motor shaft on the slip clutch from the top; push motor down until it sits on the container lid.
15. Press together each ear of the 2-ear clamp using appropriate pliers in order to clamp the slip clutch on the shaft of the agitator.
16. Insert the motor screws from below (see figure 9/2) and tighten them.
17. Briefly start up agitator to check for correct function.

CAUTION



Danger of injuries caused by rotating tools

Do not reach into the feed container when the agitator is running!

9.2 Replacing fuses



CAUTION

CAUTION

Always replace defective fuses with the same type of fuse (configuration and value).

Never repair or replace them provisionally!

The fusible cutouts can only be accessed after the protective hood has been removed.

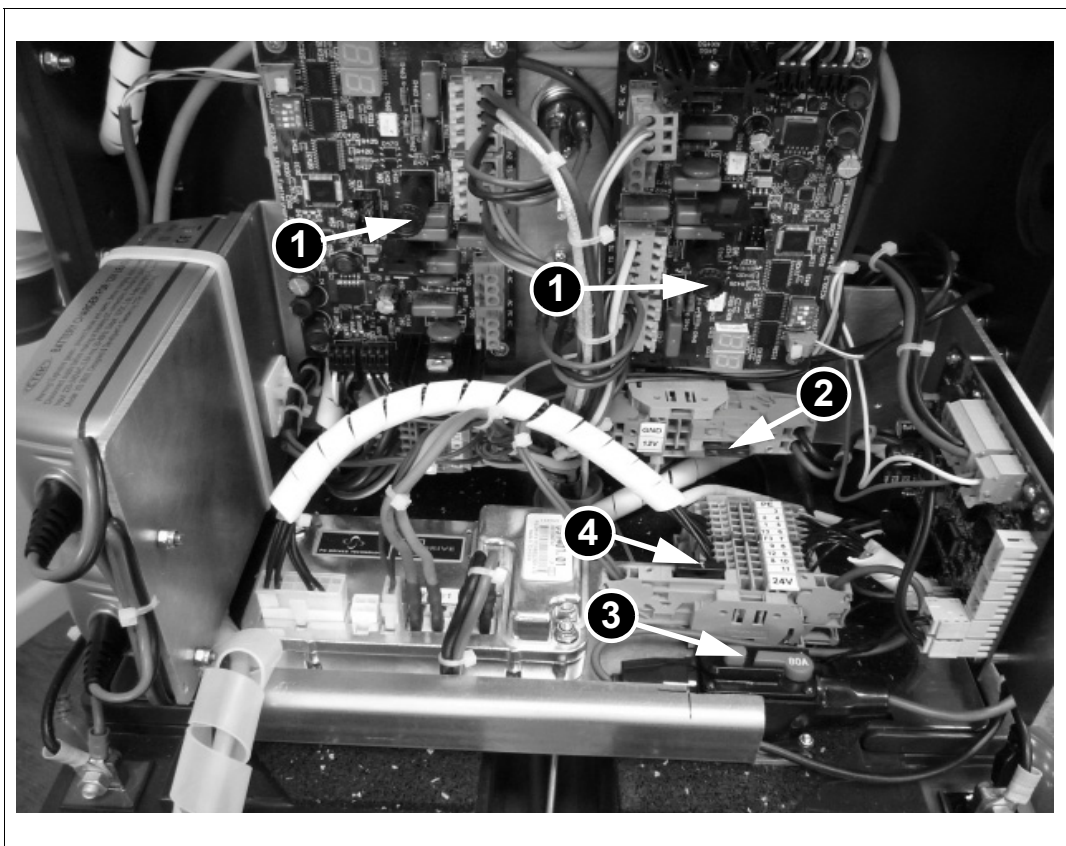

Figure 9/6: Position of fuses





WARNING

WARNING

Danger of injury due to electric shock

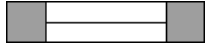
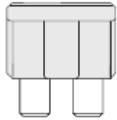
De-energise the device before opening the control housing. Pull off the connecting cable. A voltage of 12 - 24 V remains even when the connecting cable is pulled off!

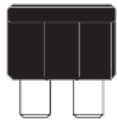
No.	Designation	Value	Fused circuit	Configuration
1	F4	6.3 A	Agitator, glass fuse 230 V	 5 x 20 mm
2	F1	10 A	Main fuse battery current 12 V Blade-type fuse	
3	F2	80 A	Main fuse propelling drive 24 V Safety cutout (resettable)	
4	F3	1 A (black)	Control-circuit fuse propelling drive 24 V	

9.3 Replace batteries

9.3.1 Replace main batteries

Required tools: Hexagon spanner 8 mm, hexagon spanner 10 mm
Allen key 6 mm

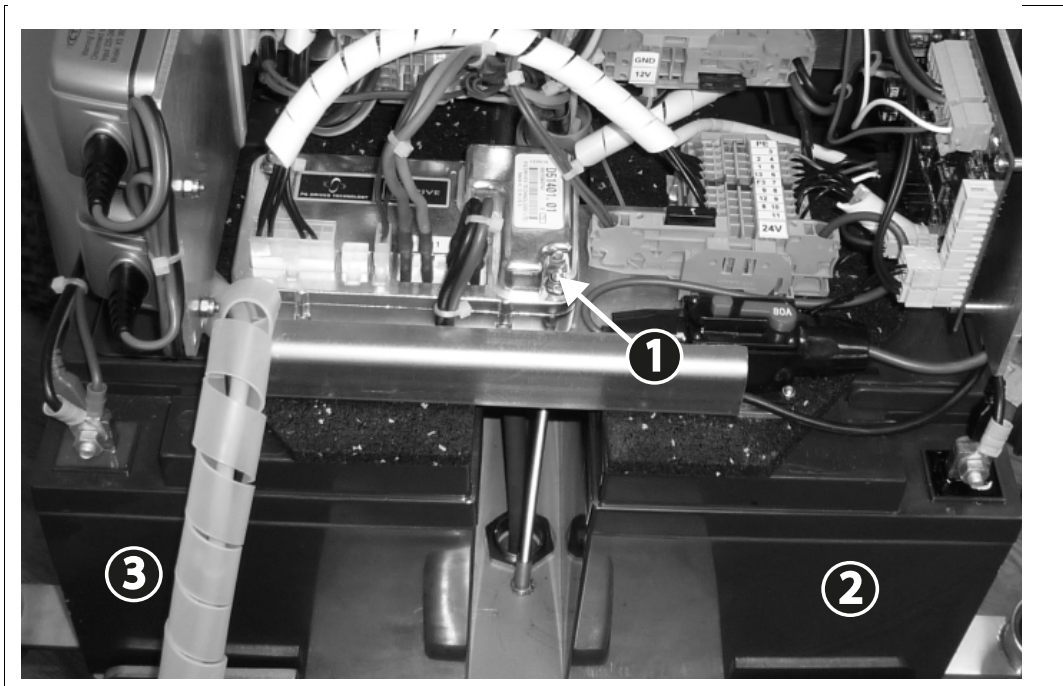

Figure 9/7: Position of battery

In order to replace batteries, carry out the following steps:

1. Unscrew the Allen screw and remove the protective hood.
2. Release the cap nut **1** and unscrew the threaded rod with the cap nut from the threaded bushing.
3. For the right battery, release the screw connection at the negative pole **2**.
4. Slightly pull out the battery and release the screw connection at the positive pole.
5. Remove the supply leads.
6. Connect the supply leads first to the positive pole of the batteries and then to the negative pole.
7. For the left battery, release the screw connection at the positive pole **3**.
8. Slightly pull out the battery and release the screw connection at the negative pole.
9. Remove the supply leads.
10. Remove the battery and replace it with a battery of identical construction.
11. Connect the supply leads first to the positive pole of the batteries and then to the negative pole.
12. Assemble the threaded rod.
13. Put on the protective hood and screw tight.

9.3.2 Replace batteries for date/time

If the wrong date and the wrong time is shown in the display, the battery of the circuit board behind the display must be replaced.



CAUTION

- Do not use metallic tools to replace the battery.
- Use only batteries of the type 3 V lithium CR 2032.

To replace the battery, carry out the following steps:

1. Switch off the device and disconnect from the mains.
2. Open the control housing. The circuit board is located in the housing lid.
3. With a slight twist, press the battery **1** against the bottom spring bracket **3** and pull up to remove.

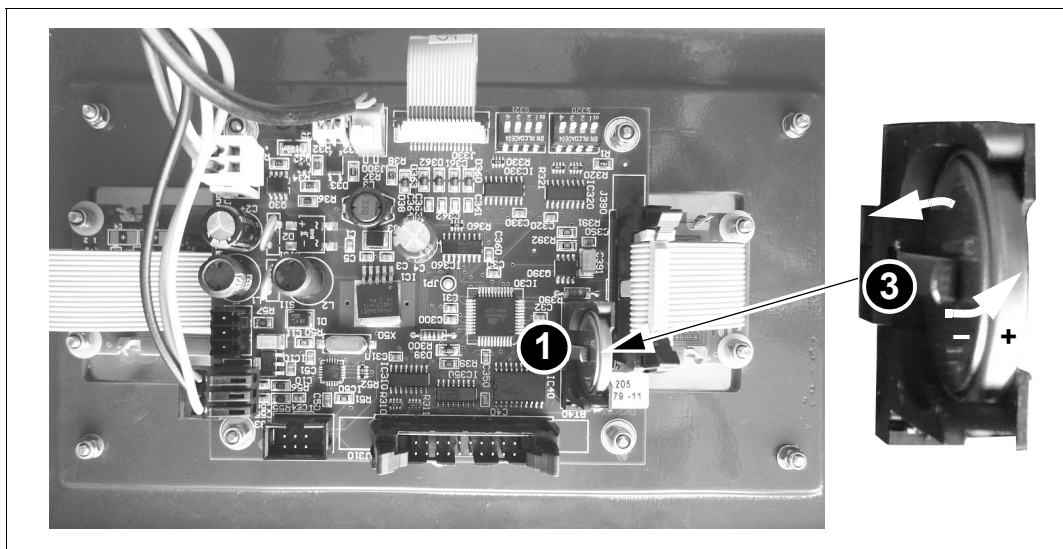

Figure 9/8: Remove battery for date/time

Correctly insert new battery **2** (negative pole of battery at spring bracket **3** of the battery holder).

First position the battery at a slight angle up to the bottom stop of the battery holder and then press into the final position.

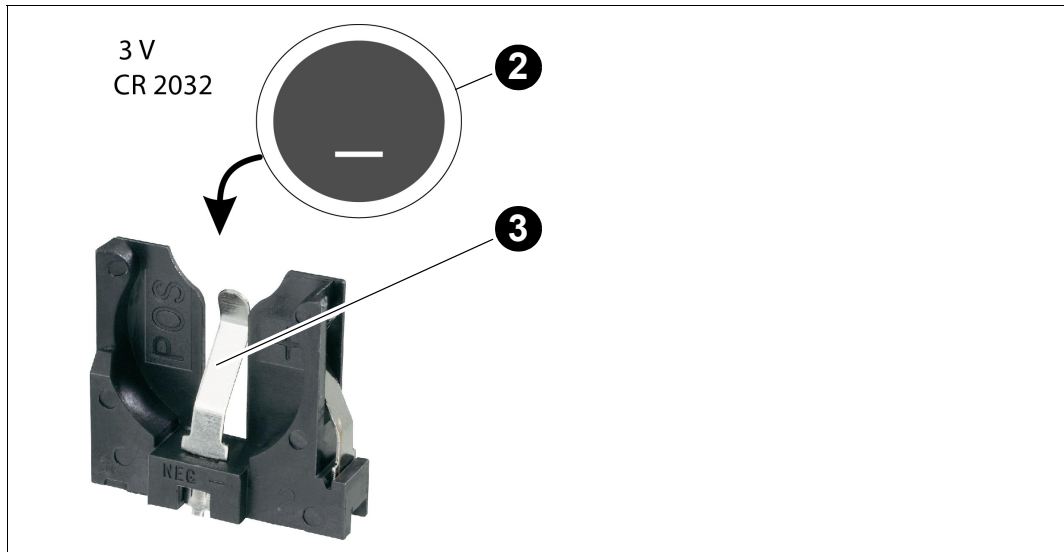

Figure 9/9: Insert battery for date/time

4. Close the control housing.
5. Switch on the device.
6. Set the date and time (see chapter 7.1.1)

Information



INFO

- The entered feeding data of the last 24 hours may have been lost due to the battery replacement. When recommissioning the Milk Shuttle, check the settings in the display. Older feeding data are retained.
- Dispose of spent batteries according to the applicable local provisions.

9.4 Changing the wheels

9.4.1 Changing the front wheel

Required tool: Ring / open-end spanner size 19 mm



Figure 9/10: Changing the front wheel



CAUTION

Danger of injury

CAUTION

Before demounting the front wheel, secure the drawbar against falling down!

1. Securely jack up the Milk Shuttle and secure against rolling away.
2. Unscrew the wheel nut **1**.
3. Remove the axle bolt.
4. Remove the wheel.
5. Mount the spare wheel in reverse order.

9.4.2 Changing the rear wheel

Required tools: Ring / open-end spanner size 19 mm, pull-off device

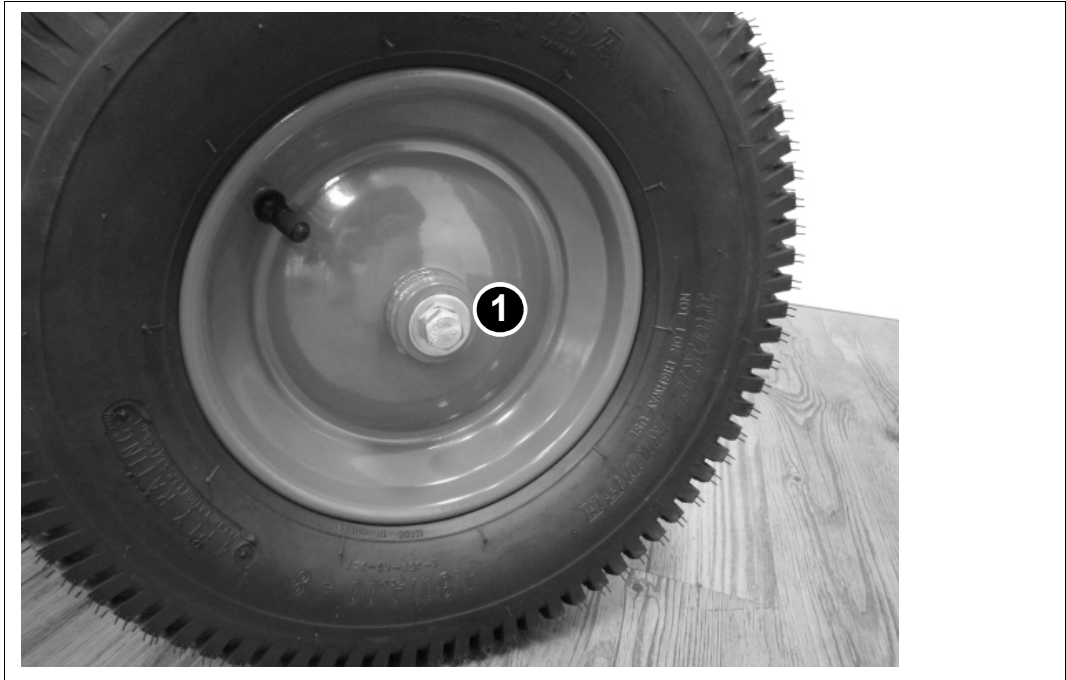

Figure 9/11: Changing the rear wheel - wheel nut

1. Securely jack up the Milk Shuttle and secure against rolling away.
2. Remove the protective cap from the wheel nut.
3. Unscrew the M 10 wheel nut ❶ .



Figure 9/12: Changing the rear wheel - pull-off device

4. Screw in pull-off device M16 ② until the wheel comes off the axle.
5. Remove the wheel.
6. Slip on the spare wheel with the tube sleeve and screw down with an M 10 wheel nut.

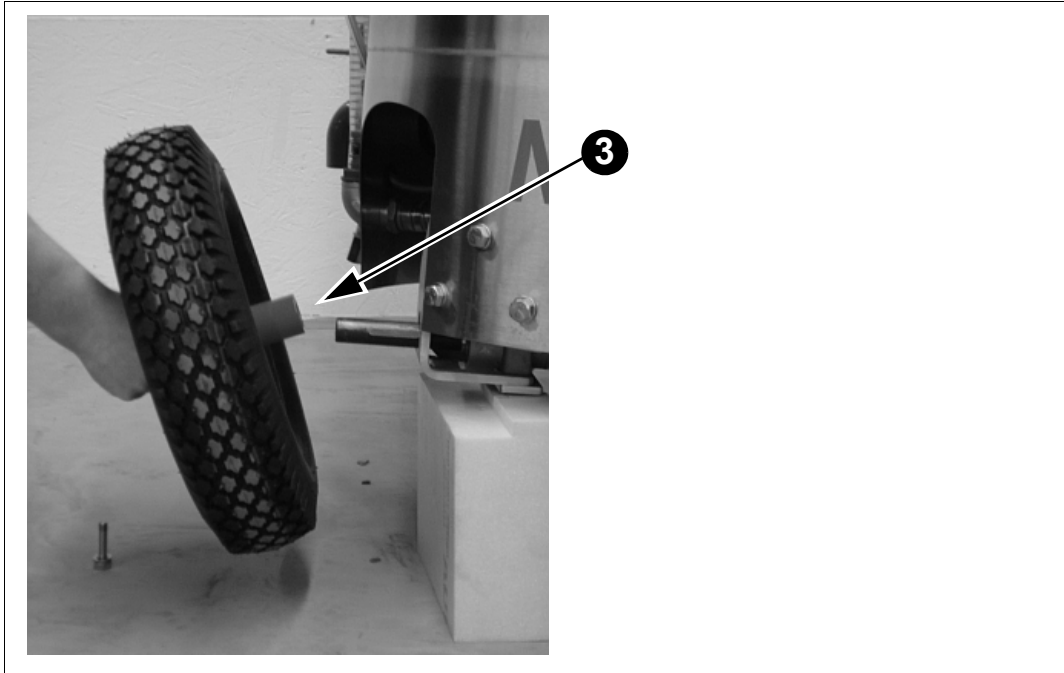

Figure 9/13: Changing the rear wheel - tube sleeve

Information



INFO

During assembly, make sure that the tube sleeve is reinserted as spacer in the wheel ③.

10 Spare parts

Article	Designation
230.201	Complete set of wearing parts consisting of: - Bearing bushing - Coupling piece - Agitator shaft wearing part - 2-ear clamp
982.357	Pneumatic tyre 400 rear axle
982.358	Pneumatic tyre 400 front axle (symmetrical)
982.399	Pneumatic tyre 400 rear axle drive
982.362	Pneumatic tyres end caps 54 mm black
982.401	Pneumatic tyres end caps 54 mm black, drive wheels
998.955	Adjusting collar for wheels, 25.2 mm with threaded pin M8x10
982.318	Suction hose 25 mm (2.5 m)
982.363	Hose securing clamp
201.881	Hose with pump nozzle and switching contact
951.185	Blade-type fuse 1 A
951.193	Blade-type fuse 10 A
951.044	Glass fuse 6.3 A

11 Mixing tables

11.1 Variant I: water volume given in litres, CMR weight given in kilograms

Target quantity (in litres)	30	40	50	60	70	80	90	100	120	140	160	180	200	220	240	250
Solids content (in %)	Required milk powder amount (in kilograms)															
10	3 27	4 36	5 45	6 54	7 63	8 72	9 81	10 90	12 108	14 126	16 144	18 162	20 180	22 198	24 216	25 225
11	3,3 26,7	4,4 35,6	5,5 44,5	6,6 53,4	7,7 62,3	8,8 71,2	9,9 80,1	11 89	13,2 107	15,4 125	17,6 142	19,8 160	22 178	24,2 196	26,4 214	27,5 223
12	3,6 26,4	4,8 35,2	6 44	7,2 52,8	8,4 61,6	9,6 70,4	10,8 79,2	12 88	14,4 106	16,8 123	19,2 141	21,6 158	24 176	26,4 194	28,8 211	30 220
13	3,9 26,1	5,2 34,8	6,5 43,5	7,8 52,2	9,1 60,9	10,4 69,6	11,7 78,3	13 87	15,6 105	18,2 122	20,8 139	23,4 157	26 174	28,6 191	31,2 209	32,5 217
14	4,2 25,8	5,6 34,4	7 43	8,4 51,6	9,8 60,2	11,2 68,8	12,6 77,4	14 86	16,8 103	19,6 120	22,4 138	25,2 155	28 172	30,8 189	33,6 206	35 215
15	4,5 25,5	6 34	7,5 42,5	9 51	10,5 59,5	12 68	13,5 76,5	15 85	18 102	21 119	24 136	27 153	30 170	33 187	36 204	37,5 213
16	4,8 25,2	6,3 33,6	8 42	9,6 50,4	11,2 58,8	12,8 67,2	14,4 75,6	16 84	19,2 101	22,4 118	25,6 134	28,8 151	32 168	35,2 185	38,4 202	40 210
17	5,1 24,9	6,8 33,2	8,5 41,5	10,2 49,8	11,9 58,1	13,6 66,4	15,3 74,7	17 83	20,4 100	23,8 116	27,2 133	30,6 149	34 166	37,4 183	40,8 199	42,5 208
18	5,4 24,6	7,2 32,8	9 41	10,8 49,2	12,6 57,4	14,4 65,6	16,2 73,8	18 82	21,6 98	25,2 115	28,8 131	32,4 148	36 164	39,6 180	43,2 197	45 205
19	5,7 24,3	7,6 32,4	9,5 40,5	11,4 48,6	13,3 56,7	15,2 64,8	17,1 72,9	19 81	22,8 97	26,6 113	30,4 130	34,2 146	38 162	41,8 178	45,6 194	47,5 203
20	6 24	8 32	10 40	12 48	14 56	16 64	18 72	20 80	24 96	28 112	32 128	36 144	40 160	44 176	48 192	50 200
Note:	Due to the solubility of the milk powder, you might have to add some water after the mixing process in order to reach the target volume.															

11.2 Variant II: water volume given in litres, CMR weight given in pounds

Target quantity (in litres)	30	40	50	60	70	80	90	100	120	140	160	180	200	220	240	250
Solids content (in %)	Required milk powder amount (in pounds)															
10	6.6	8.8	11	13.2	15.4	17.6	19.8	22	26.5	30.9	35.3	39.7	44.1	48.5	52.9	55.1
11	7.3	9.7	12.1	14.5	17.0	19.4	21.8	24.3	29.1	34.0	38.8	43.7	48.5	53.4	58.2	60.6
12	7.9	10.6	13.2	15.9	18.5	21.2	23.8	26.5	31.7	37	42.3	47.6	52.9	58.2	63.5	66.1
13	8.6	11.5	14.3	17.2	20.0	22.9	25.8	28.7	34.4	40.1	45.9	51.6	57.3	63.1	68.8	71.7
14	9.3	12.3	15.4	18.5	21.6	24.7	27.8	30.9	37	43.2	49.4	55.6	61.7	67.9	74.1	77.2
15	9.9	13.2	16.5	19.8	23.1	26.5	29.7	33.1	39.7	46.3	52.9	59.5	66.1	72.8	79.4	82.7
16	10.6	14.1	17.6	21.2	24.7	28.2	31.8	35.3	42.3	49.4	56.4	63.5	70.5	77.6	84.7	88.2
17	11.2	15	18.7	22.5	26.2	30	33.7	37.5	45	52.5	60	67.5	75	82.5	90	93.7
18	11.9	15.9	19.8	23.8	27.8	31.7	35.7	39.7	47.6	55.6	63.5	71.4	79.4	87.3	95.2	99.2
19	12.8	16.8	20.9	25.1	29.3	33.5	37.7	41.9	50.3	58.6	67	75.4	83.8	92.2	100.5	105
20	13.2	17.6	22	26.5	30.9	35.3	39.6	44.1	52.9	61.7	70.6	79.4	88.2	97	106	110
	24	32	40	48	56	64	72	80	96	112	128	144	160	176	192	200
Note: Due to the solubility of the milk powder, you might have to add some water after the mixing process in order to reach the target volume.																

11.3 Variant III: water volume given in gallons, CMR weight given in pounds

Target quantity (in litres)	30	40	50	60	70	80	90	100	120	140	160	180	200	220	240	250
Solids content (in %)	Required milk powder amount (in pounds)															
10	6.6	8.8	11	13.2	15.4	17.6	19.8	22	26.5	30.9	35.3	39.7	44.1	48.5	52.9	55.1
11	7.3	9.7	12.1	14.5	17.0	19.4	21.8	24.3	29.1	34.0	38.8	43.7	48.5	53.4	58.2	60.6
12	7.9	10.6	13.2	15.9	18.5	21.2	23.8	26.5	31.7	37	42.3	47.6	52.9	58.2	63.5	66.1
13	8.6	11.5	14.3	17.2	20.0	22.9	25.8	28.7	34.4	40.1	45.9	51.6	57.3	63.1	68.8	71.7
14	9.3	12.3	15.4	18.5	21.6	24.7	27.8	30.9	37	43.2	49.4	55.6	61.7	67.9	74.1	77.2
15	9.9	13.2	16.5	19.8	23.1	26.5	29.7	33.1	39.7	46.3	52.9	59.5	66.1	72.8	79.4	82.7
16	10.6	14.1	17.6	21.2	24.7	28.2	31.8	35.3	42.3	49.4	56.4	63.5	70.5	77.6	84.7	88.2
17	11.2	15	18.7	22.5	26.2	30	33.7	37.5	45	52.5	60	67.5	75	82.5	90	93.7
18	11.9	15.9	19.8	23.8	27.8	31.7	35.7	39.7	47.6	55.6	63.5	71.4	79.4	87.3	95.2	99.2
19	12.8	16.8	20.9	25.1	29.3	33.5	37.7	41.9	50.3	58.6	67	75.4	83.8	92.2	100.5	105
20	13.2	17.6	22	26.5	30.9	35.3	39.6	44.1	52.9	61.7	70.6	79.4	88.2	97	106	110
Note:	Due to the solubility of the milk powder, you might have to add some water after the mixing process in order to reach the target volume.															

Index**A**

Adjusting the track width	26
Agitate	32
Agitator	
Motor switch	19
Select speed.....	33

B

Battery	39
Bearing bushing	71

C

Calibration	48
Pump	
time-controlled	48
with flow meter.....	49
Temperature	50
Charge condition	38
Connecting cable.....	27

D

Danger of frost.....	31
Daylight savings	45
Detergent.....	39
Display lighting	32
Drawbar head.....	21, 42

E

Electrical connection	27
Emergency	12

F

Feeding	36
Filling the feed	34

H

Heater.....	26
Heating	32
Housing closure.....	19
Housing closures.....	19

I

Intended use	12
--------------------	----

L

Language	
available languages.....	16
national language	46
Language package	
available packages.....	16
determine via operating code	70
Long-term operation (agitator).....	34

M

Mixing CMR.....	34
Mixing tables	34, 85–87
Mixing temperature.....	34
Mixing the feed	34

N

Name plate	14
National language	see Language

O

Operating code.....	70
Operating panel.....	18, 31
Operation.....	33

P

Preselection keys	40
Cleaning programs	40
Programming	40
Programming mode	45, 51, 55
Propelling drive clutch lever	20
Pump nozzle	
actuate.....	38
Locking device.....	38

R

Removing/dosing feed.....	36
---------------------------	----

S

Schematic structure of the Milk Shuttle ...	15
Scope of delivery	23
Serial numbers	47
Shaft (agitator).....	72
Slip clutch	71, 72
Snap closure	19
Standby	33
Strong soiling.....	39
Summertime	45
Switching off	31
Switching on	31

T

Temperature warning level.....	47
Transportation	23
Trunnion	71, 72

U

Unpacking	24
-----------------	----

V

Version numbers	47
-----------------------	----

W

Warning symbols.....	8
Whole milk.....	35
Wintertime	45

Urban GmbH & Co. KG
Auf der Striepe 9

D-27798 Wuesting, Germany

Telephone: +49/(0) 44 84/93 80-0
Fax: +49/(0) 44 84/93 80-10

info@urbanonline.de
www.urbanonline.de

